

Measurement of periodic optics in the CTF3 combiner ring

Pierre-Louis Pernet

École Polytechnique Fédérale de Lausanne, Lausanne, Switzerland

Simona Bettoni, Piotr Skowronski, Frank Tecker and Rogelio Tomás García

CERN, Geneva, Switzerland

Tatiana Pieloni

Paul Scherrer Institut, Villigen, Switzerland

Abstract

After a successful commissioning of the *CTF3* combiner ring (*CR*), its optics has to be precisely measured. This note explores the possibility of using the Beam Position Monitor (*BPM*) turn-by-turn data to measure the tune and the phase advance between *BPMs*. A computer code has been developed to acquire the beam current, the horizontal and the vertical position from all the *BPMs* and *BPIs* around the ring. These raw data can be then processed in order to extract the bunch position for each turn. Optical functions can be computed thanks to three different algorithms: model fitting, frequency analysis by Sussix and Singular Value Decomposition (*SVD*). Four experimental sessions and computing simulations using *MAD-X* are presented in this note addressing the performance and the limitations of this technique in the *CTF3* combiner ring.

Geneva, Switzerland

February 4, 2010

Contents

- 1 Introduction** **3**

- 2 Transversal dynamics theory [4]** **5**

- 3 Acquisition and processing of the raw data** **6**
 - 3.1 Computing implementation 6
 - 3.2 BPM data acquisition 6
 - 3.3 Processing the raw data 7

- 4 Analysis of the measurements** **10**
 - 4.1 The algorithms 10
 - 4.2 Comparison with the model 12
 - 4.3 Performance of the method 14

- 5 Experimental results** **15**
 - 5.1 Logbook of the measurement sessions 15
 - 5.2 Tune measurement 16
 - 5.3 Phase advance measurement 18

- 6 Conclusion** **19**

- A Graphical User Interface** **21**

- B List of the different BPMs and BPIs** **22**

- References** **23**

1 Introduction

A new era for high energy physics will start at the end of this year, when the Large Hadron Collider (*LHC*) will come into service. One of the most promising goal of this collider is to go beyond the Standard Model by discovering new particles at high energies, predicted by theories like the *SU*per*SY*mmetry (*SUSY*) for instance. These particles will be produced by the collisions of protons at the energy of 14 TeV in the centre of mass reference. Hadronic colliders are the most suitable for discoveries, however due to the fact that protons are not primary particles, but composed of three quarks, the energies involved are not known with a very good precision. A lepton collider will be needed to measure precisely the mass of these new particles in order to complete the theories. To obtain interesting physics events, an energy of at least 500 GeV will be required, which forces this future collider to be linear due to the intense synchrotron radiation in circular colliders at Higgs energy. Two major international projects are under design study. The first one is the International Linear Collider (*ILC*) which will use superconducting Radio Frequency (*RF*) cavities. The second one is the Compact Linear Collider (*CLIC*) developed at *CERN* by a collaboration of 33 institutes from all over the world.

Still in the R&D design prove of feasibility phase, *CLIC* will enable to accelerate and collide electrons against positrons at the nominal centre of mass energy of 3 TeV, which is more than 14 times the *LEP* energy. This performance can be realised thanks to an accelerating gradient of 100 MV/m on a total distance of 48 km at the room temperature [1]. This innovation resides in the two beam acceleration technology.

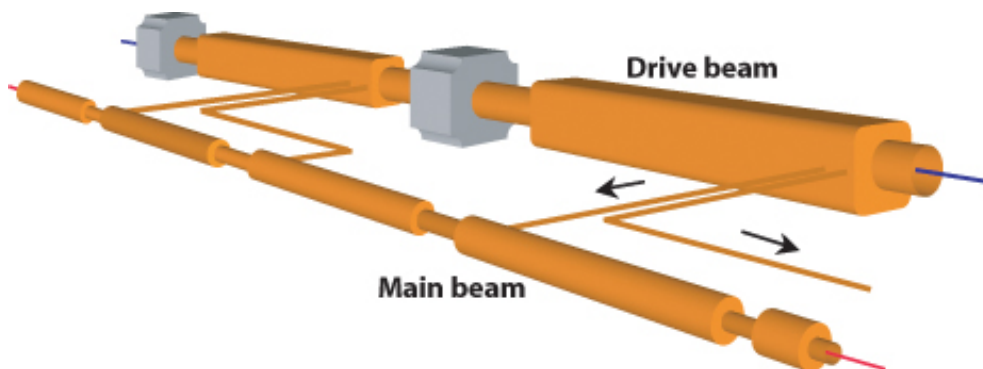

Figure 1: The scheme of a *CLIC* module with the two beam acceleration [2].

To obtain this large gradient, *RF* sources are needed at the high frequency of 12 GHz. The energy is transferred from an electron drive beam, see Fig. 1, during its deceleration in some Power ExtracTion Structures (*PETS*). This acceleration concept has not been yet used in other accelerators, therefore its feasibility has to be demonstrated experimentally. This is one of the major goal of the *CLIC* Test Facilities, the current one being the third generation: *CTF3*, see Fig. 2. After being produced by a thermionic gun, the electron beam is accelerated through a linac and the bunch frequency is increased first with the delay loop by a factor of two and then by the combiner ring by a factor of four in order to be used in the high-power test-stand for the drive beam [3].

The combiner ring enables to combine four bunch trains, reducing the space between two consecutive bunches from 10 cm to 2 cm. This is performed thanks to two *RF* deflectors that combine four pulses which perform from $1/2$ to $3+1/2$ turns before being extracted altogether by a kicker (extraction dipole magnet) [3].

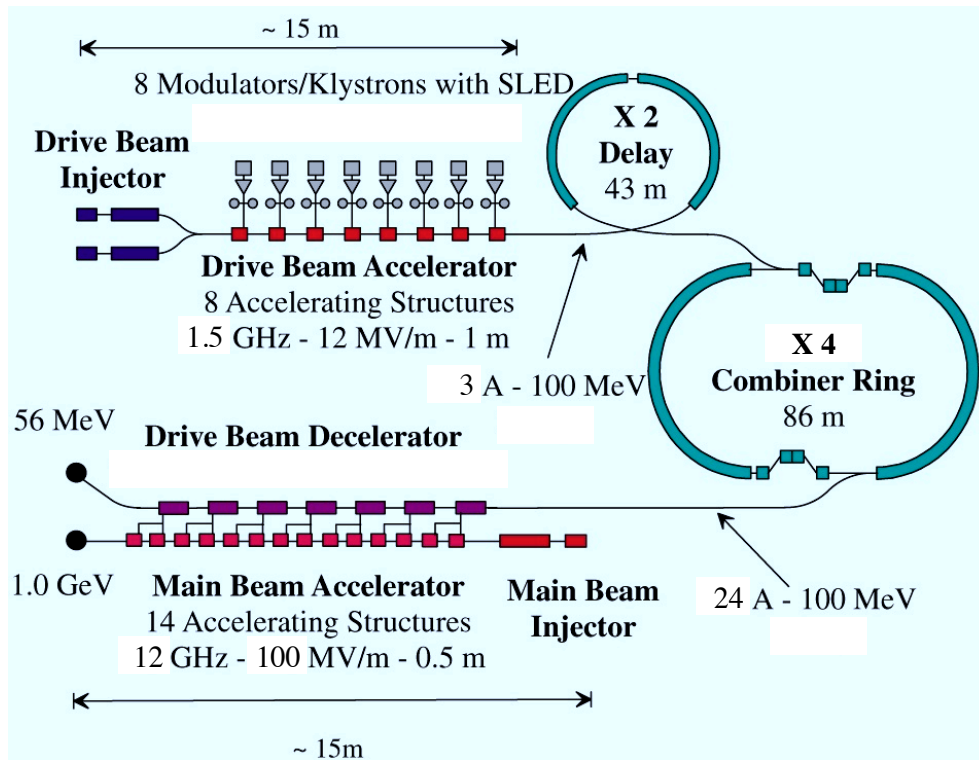

Figure 2: The scheme of a drive beam generation, acceleration and *RF* multiplication [2].

The combiner ring has been successfully commissioned, however its optics has to be studied in detail. The tunes and the phase advances can be experimentally obtained from the beam position monitor data by using different algorithms: the Fourier transform, the model fitting and finally the Singular Value Decomposition (*SVD*). The limitations of the measurement are probed via computing simulations.

2 Transversal dynamics theory [4]

The usual reference system to track particles around a ring is the local curvilinear frame, shown in Fig. 3. The displacement from the design orbit in the transverse plane is represented by x (horizontal) and y (vertical), while s measures the motion along the design orbit. The quantity $\rho(s)$ is the local radius of curvature. The motion of one particle is described in the phase space by (x, x', y, y') , where x' and y' are the transverse slopes of the trajectory defined respectively by $x' = \frac{dx}{ds}$ and $y' = \frac{dy}{ds}$.

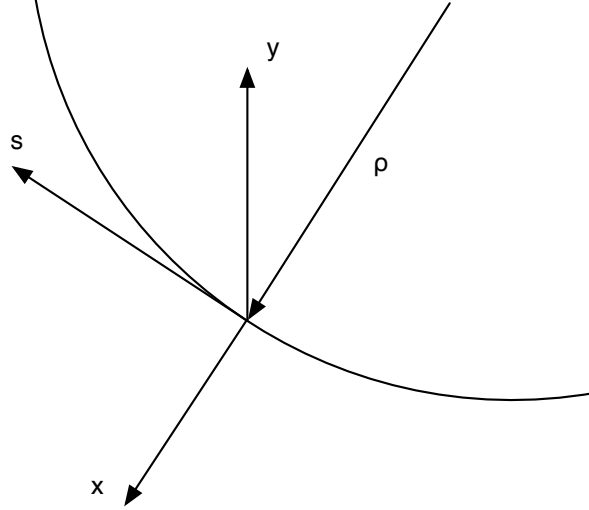

Figure 3: Local curvilinear coordinates system.

The transversal motion of the particles is described by the Hill equations, where $K(s)$ is a periodic function determined by the strength of the lattice dipoles and quadrupoles. For the horizontal direction, the equation of motion is the following:

$$x''(s) + K(s)x(s) = 0 \quad (1)$$

If the periodicity condition is added, i.e. $K(s + C) = K(s)$, with C being the circumference, a “pseudo-harmonic oscillator” solution can be parametrized as:

$$x(N, s) = \sqrt{\epsilon_{cs}\beta_x(s)} \cos(2\pi Q_x N + \phi_x(s)) \quad (2)$$

Here ϵ_{cs} represents the Courant-Snyder invariant, which is a property of the particle, and $\beta(s)$ is a positive periodic function, defined as beta-function. The number of betatronic oscillations along the ring is given by the tune $Q_x = \frac{1}{2\pi} \oint \frac{ds}{\beta_x(s)}$ in the horizontal direction (Q_y in the vertical one). The phase $\phi_x(s)$ is related to the $\beta_x(s)$ function by the formula $\phi_x(s) = \int_0^s \frac{ds}{\beta_x(s)}$.

3 Acquisition and processing of the raw data

3.1 Computing implementation

Different programs have been developed to study the optics of the *CTF3* combiner ring. The computing language chosen is C++. The source code can be downloaded at:

```
http://ppernet.web.cern.ch/ppernet/CLIC/CTF3CR.zip
```

The external library Root is used to plot data, to create a graphical interface and for some useful routines already implemented inside it, like for instance the Fast Fourier Transform (*FFT*) or the χ^2 fit method. The version used is the 5.24/00, this one is available on AFS for different platforms and compilers at:

```
/afs/cern.ch/sw/lcg/app/releases/ROOT/5.24.00/
```

This environment can be also easily set up directly by typing the following command in the source code folder: `source root.csh`. To compile the code on Linux, one needs to log in into the `cs-ccr-dev1` or `cs-ccr-dev2` computers in order to have access to the beam position monitor system libraries. The command `make` in a terminal creates five executables compatible with 32 and 64 bits architectures: `Acquire`, `Castor`, `Process`, `Analyse` and `GUI`. The last one is a Graphical User Interface (*GUI*) which combines the previous codes, see Appendix A for more information. All the temporary object files can be removed with the command: `make clean`.

3.2 BPM data acquisition

The `Acquire` program enables to read all the turn-by-turn data from the Beam Position Monitor system of the *CTF3* combiner ring. The list of the different *BPMs* and *BPIs* has to be written in the `Input/BPMs.dat` file with the MAD-X input syntax, see Appendix B for more details. Each line represents a device¹⁾, a format example follows:

```
ptc_observe, place= "CR.BPI0130";
```

For each device, the cycle `STC.USER.SETUP` is selected, the current, the horizontal and the vertical positions from the analog²⁾ and the digitalised signal are read and saved in different files inside a directory, for instance `Raw/Time_Tue_11_Aug_2009_at_15_33_08/`. In the first line of each file, the sampling size, the time unit factor and the sampling train are written in a comment. If a value is equal to Not a Number (*NaN*), it will appear as -999 in these files.

¹⁾ The complete list of the combiner ring *BPMs* and *BPIs* is available at: <http://www.wpsco.cern.ch/>

²⁾ For the *BPIs*, the analog positions correspond to the diagonal electrodes.

These raw data can be stored on the CERN Advanced STORAge manager (*CASTOR*) [5], with the *Castor* program in an archive. The account username and the folders have to be passed in arguments, for example:

```
./Castor ppernet Raw/Time_Tue_11_Aug_2009_at_*
```

All the raw data presented in this paper are available from the *CTF3* control room network at: `/nfs/cs-ccr-nfs6/vol28/u1/ctf3op/2009/CombinerRingSummer/Raw/` and also at: `/castor/cern.ch/user/p/ppernet/`.

3.3 Processing the raw data

An electron bunch travels around the combiner ring in 280 ns. The *CTF3* combiner ring *BPMs*³⁾ are able to acquire from 1 to 140 turns, depending on the settings of the system. When a bunch is present inside a *BPM*, a non null current is detected, see Fig. 4. The horizontal and vertical positions of the bunch are also measured, see Fig. 5 for the horizontal one.

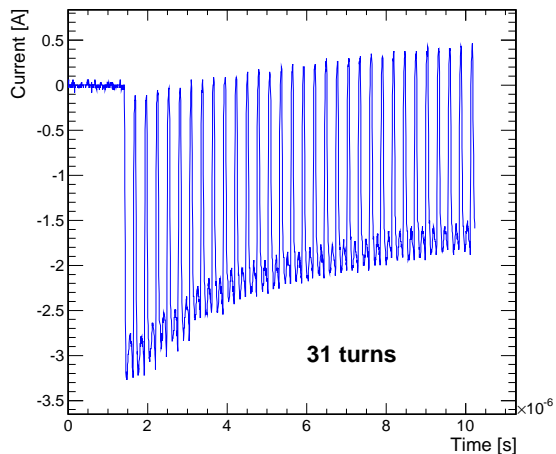

Figure 4: Example of digitalised raw current data as a function of time from BPI0775.

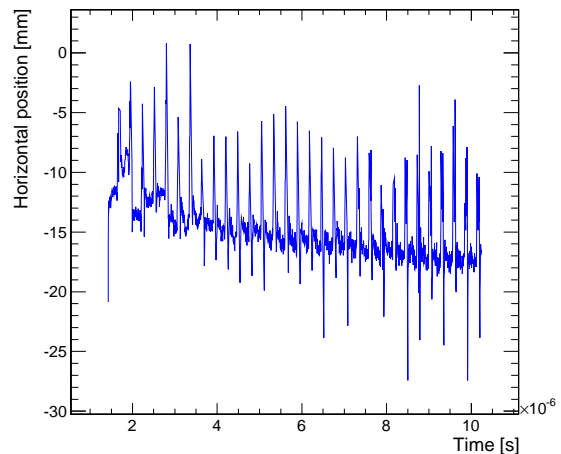

Figure 5: Example of raw horizontal position data as a function of time from BPI0775.

Some unwanted features are present for the turn-by-turn position extraction. First, some particles are lost in the combiner ring, which lowers the current in the *BPMs*. Then there is a current drift only for the *BPIs*, coming from a too high low frequency cut which reduces the quality of the signal. Therefore a simple threshold cannot be applied, but a human window selection aided by the *GUI* is required. This solution has been implemented in the `Process` program. Once launched, the raw data folder path has to be entered in the prompt command. The current raw data for the first *BPM* is displayed, for the combiner ring this one is BPI0130.

³⁾ From now, *BPMs* stands for *BPMs* and also *BPIs*.

The *GUI* allows to select the starting point and the range for the first turn as shown in Fig. 6, thanks to a slider, for more information see Appendix A. The turn revolution being periodic, a *FFT*⁴⁾ can be applied on this signal. The main frequencies will appear in the spectral domain, see Fig. 7.

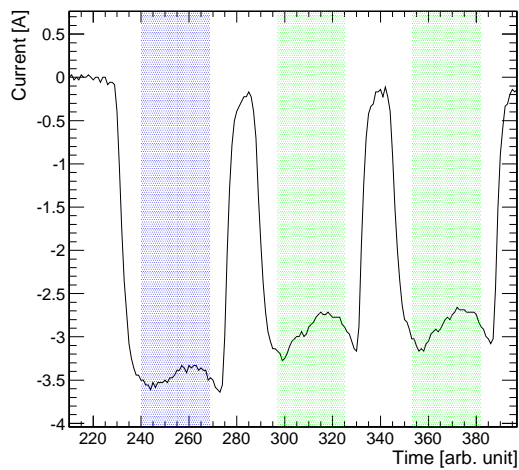

Figure 6: The turn-by-turn extraction algorithm: the blue window corresponds to the first turn, the green windows are automatically placed for the other turns thanks to the *FFT*.

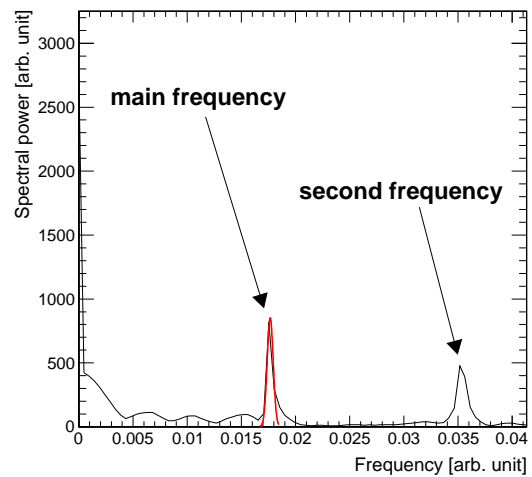

Figure 7: Frequency domain of the current signal coming from a *FFT* where the main peak is fitted.

The first peak, main peak in Fig. 7, corresponds to the revolution frequency, the second one results from the step shape of the signal, i.e. the bunch train length. The revolution frequency value is exactly found by a Gaussian fit using the χ^2 minimization method⁵⁾. This value can also be finely adjusted thanks to the *GUI*. The windows for the other turns are automatically positioned on the raw current data, thanks to this frequency.

⁴⁾ The routine used here comes from the *FFTW* package, for more information see: <http://www.fftw.org/>

⁵⁾ The routine explanations are available at: <http://root.cern.ch/root/html/TGraph.html#TGraph:Fit>

For the positions computation, the average of the points inside the different windows of the raw horizontal and vertical data is done. In order to directly see the robustness of this algorithm, the preview of the horizontal and vertical processed positions for the first *BPM* is displayed, see Fig. 8. This one is always refreshed when the window range is changed.

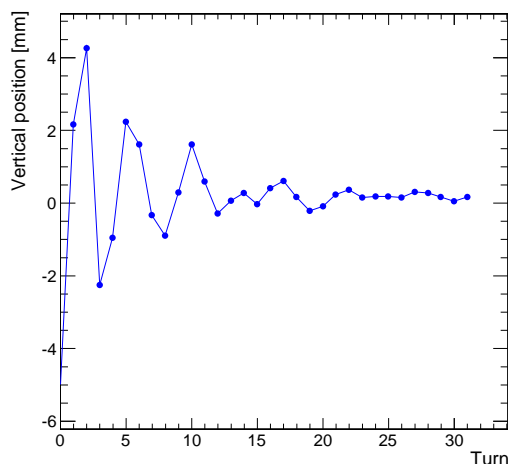

Figure 8: Preview of the processed vertical position for the first *BPM*.

When all the parameters are properly set, this calculation is performed for every *BPM*. The algorithm takes into account that signals from the different *BPMs* are not starting at the same time, but with a small delay corresponding to the electrons time of flight. These data are finally stored in a file in the `Processed` directory. The output file has the same format than MAD-X coupled with the `AddBpmErrors` script⁶⁾, for example:

```
# title
0 CR.BPI0130 0 22.7155 1.50898 0.108739 -0.215696 1.26209
1 CR.BPI0130 0 2.0205 1.78588 2.52383 3.4343 2.97238
```

The first column stands for the plane: 0 for the horizontal and 1 for the vertical one. The second column is a *BPM* name and then its longitudinal position in the ring⁷⁾. Finally the position values for each turn are displayed until the end of the line.

⁶⁾ This script is available in the MAD-X folder.

⁷⁾ The position of the *BPMs* being not used for the analysis, they can be set to 0 in the processed files.

4 Analysis of the measurements

4.1 The algorithms

In the combiner ring, the electrons are oscillating around the closed orbit, their position is described by Eq. (2). The tune Q and the phase ϕ depend on the magnet strengths. These two parameters have to be extracted from the measured data in order to deduce the optics of the *CTF3* combiner ring. Three different methods are available to perform this computation. The first is one is the model fitting of the data, the second one is using the SUBtraction of Spectral lines from SIXtrack (more known as Sussix) algorithm and finally the last one is the Singular Value Decomposition (*SVD*) of a turn-by-turn *BPM* data matrix.

Model fitting One solution to determine the different parameters of Eq. (2) is to fit the model of the combiner ring optics function to those extracted from the measured data. In order to take into account the damping of the oscillations due to chromaticity, the function used for the fitting is the following:

$$f(N) = (\alpha \cdot e^{N/\tau} + \alpha_0) \cos(2\pi QN + \phi) \quad (3)$$

The exponential part models the position damping. The fit routine used here comes from the Root library [6]. In order to improve the convergence rate, the parameters for the tune are limited, from 0.7 to 0.8 for the horizontal tune and for the vertical one. The number of turns fitted is also limited to the first 40 turns, after this turn, there is full damping. The χ^2 test is used to reject bad fits, the selection threshold is chosen to be $\chi^2/n = 1.5$, where n is the number of degrees of freedom [7]. To be consistent with the other algorithms, the phase is in 2π units.

Sussix The Sussix program has been developed to postprocess tracking or experimental data via frequency analysis, see Fig. 9 for instance and for more information see [8]. As for the previous method, only the 40 first turns are analysed.

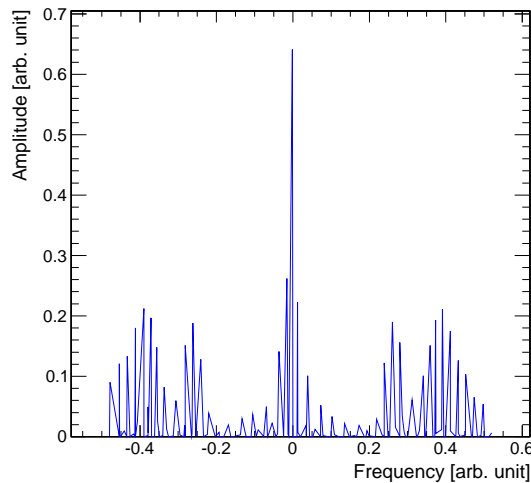

Figure 9: Spectral decomposition of the horizontal position for BPM0155.

SVD The latest method is the Singular Value Decomposition (*SVD*) of a *BPM* matrix, for more information see [9]. This method is very precise to find the phase, but it does not directly provide a tune measurement.

All these three methods have been implemented and can be applied on the acquired data with the `Analyse` executable. This code asks first the path to the data, and then the method to be used for the analysis:

```
Method: [ ] Fit, [ ] Sussix, [ ] SVD (y or n)
```

The answer `yyy` will run the three methods, whereas `y nn` will apply only the fitting one. The three parameters describing the betatron oscillations: $\sqrt{\beta\epsilon}$, Q and ϕ are plotted as well as the phase advance between two following *BPMs* which enables to see the errors of the combiner ring. The analysis results are stored in the `Results/` directory.

4.2 Comparison with the model

In order to test the robustness of these three different algorithms, computer simulations are needed. The MAD-X model used to simulate the *CTF3* combiner ring comes from the repository `ctf3model` available on the Concurrent Versions System (CVS)⁸⁾. The *RF* injector kickers are set to zero. The current of the quadrupole CR.IQDG0140 has been decreased by 10% to lower the vertical tune from 0.9 to 0.8, far from the integer resonance. The Polymorphic Tracking Code (*PTC*) [10] is used for the electrons tracking. The evolution of the horizontal and vertical position of one single electron is simulated for 70 turns, at the start of the ring its initial conditions are $x = 3$ mm and $y = 3$ mm, Fig. 10 shows the evolution of the horizontal position.

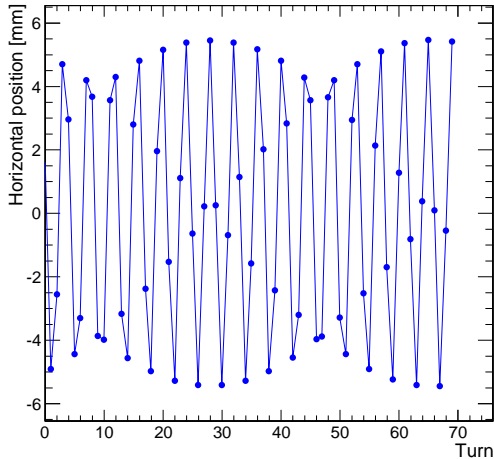

Figure 10: A single electron tracked in the combiner ring with MAD-X, data extracted at BPI0130.

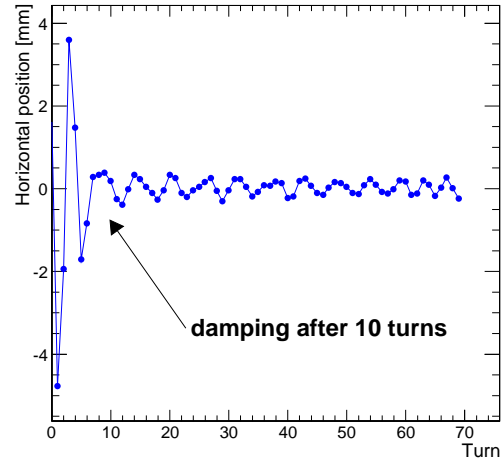

Figure 11: Horizontal position from a multi-particle simulation with uncorrected chromaticity, showing the strong damping. Data are extracted at BPI0130.

Typically, chromaticity is not corrected in the *CTF3* combiner ring, leaving the sextupoles switched off. This causes a strong decoherence due to the large tune spread induced by the natural chromaticity. To model this effect, a bunch of 1000 electrons is simulated with a momentum distribution $\Delta p/p$ following a Gaussian distribution centred at the origin and with a standard deviation of $\sigma = 0.5\%$. After 10 turns, the horizontal and vertical positions are almost null, see Fig. 11, as similarly observed in the measurements, Fig. 8.

⁸⁾ A web interface is available at: <http://cvcs.web.cern.ch/cvcs/>

On these two simulated sets of data, the three different algorithms are applied in order to compare the output results. The vertical tune and the phase advance, the most relevant parameters, are compared to the model in Figs. 12 and 13 for the single particle simulation, and Figs. 14 and 15 for the multi-particle simulation featuring the strong damping.

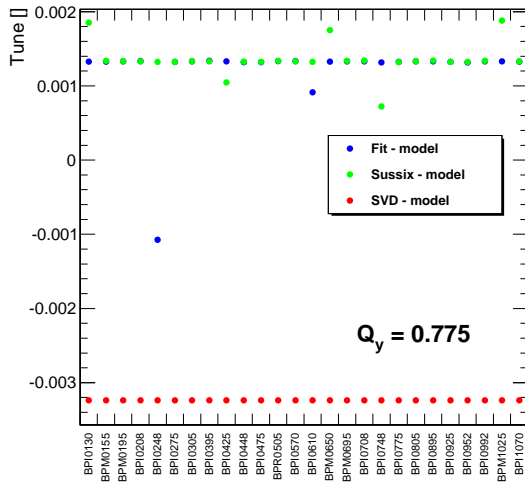

Figure 12: Vertical tune for the single particle simulation according to the algorithm used.

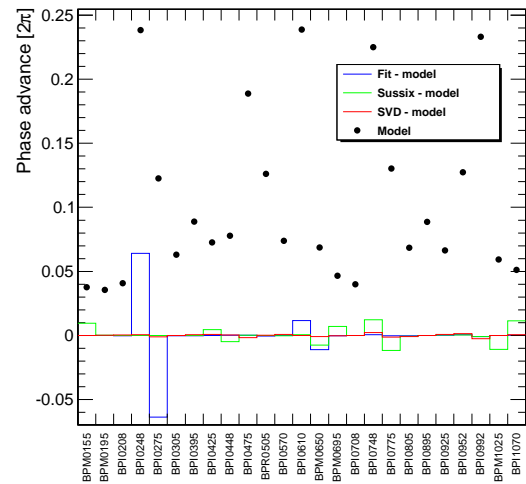

Figure 13: Vertical phase advance for the single particle simulation according to the algorithm used.

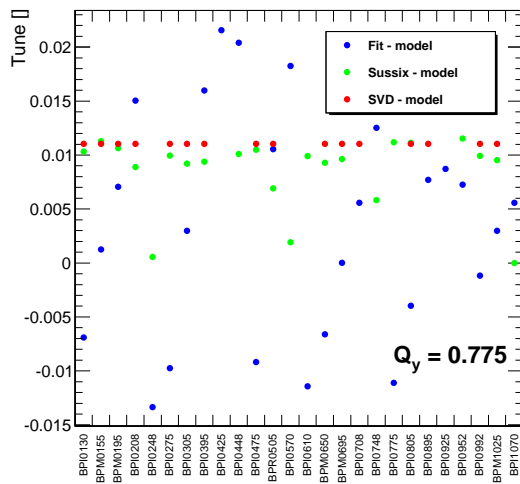

Figure 14: Vertical tune for the multi-particle simulation according to the algorithm used.

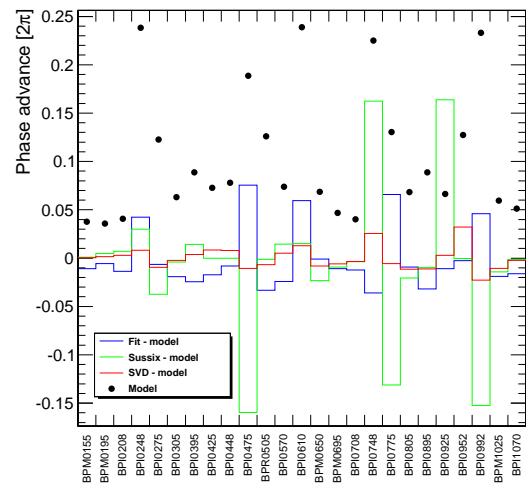

Figure 15: Vertical phase advance for the multi-particle simulation according to the algorithm used.

There are some differences between these three methods and the model. The *SVD* algorithm suffers from a lack of accuracy in the tune determination due to its use of a *FFT*. This method needs the same number of turns for every *BPM*, in order to determine the singular values. However, this is not always the case in the measured data.

Without any damping, the fit and Sussix are giving almost the same results and are in general closed to the model, nevertheless once the signal is damped the fit is losing some accuracy in the results, especially for the tune. Indeed, its results really depend on the initial input parameters, and their limits, but also on the damping mechanism modeled by the exponential factor. Sussix, being independent of these external factors, is chosen as the best algorithm for the following studies.

4.3 Performance of the method

The theoretical accuracy of the tune determination can be computed thanks to MAD-X simulations. An electron with initial conditions $x = 3$ mm and $y = 3$ mm at the start, is performing 40 turns. Random errors, following a Gaussian distribution, are added to the *BPMs* position data, using the `AddBpmErrors` script.

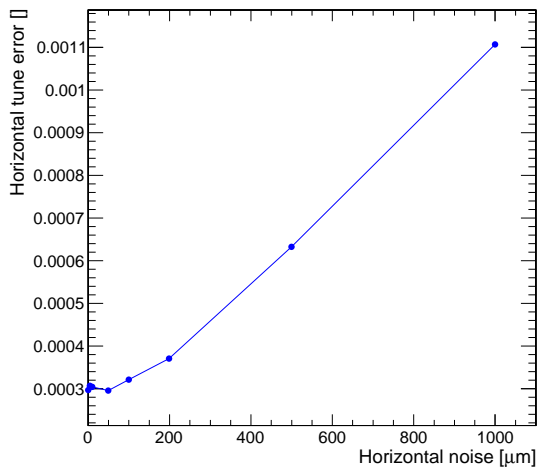

Figure 16: Horizontal tune error as a function of the horizontal noise.

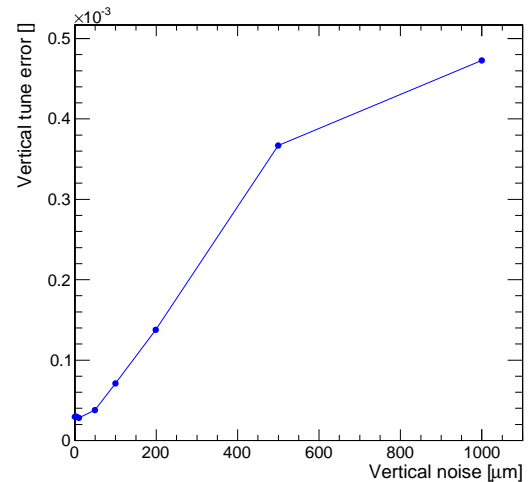

Figure 17: Vertical tune error as a function of the vertical noise.

The errors on the horizontal and the vertical tunes increase respectively with the horizontal and vertical noise, as illustrated in Figs. 16 and 17. A minimum uncertainty of $3 \cdot 10^{-4}$ is expected for the horizontal tune, and less than $1 \cdot 10^{-4}$ for the vertical one. This asymmetry between the two directions comes from the Courant-Snyder emittance difference given by the initial conditions, $\epsilon_x = 3.7 \cdot 10^{-6}$ m and $\epsilon_y = 2.2 \cdot 10^{-6}$ m.

5 Experimental results

5.1 Logbook of the measurement sessions

In order to test this measurement technique in the combiner ring, four experimental sessions of about 4 hours were used. As for the model, electrons have to travel several turns in the combiner ring and the different *BPMs* have to acquire all these turns, therefore the machine has been set up for multi-turn. This number of turns varies between 5 and more than 140 according to the technical set-up of the machine. A requirement to improve the tune and the phase advance measurement is to excite horizontal and vertical betatron motion, see Fig. 18. This is typically referred as a kick. This one is of the order of $3 \sim 4$ mm.

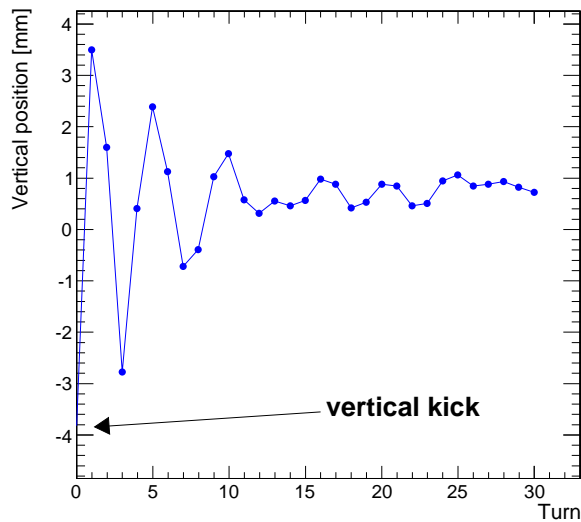

Figure 18: Vertical orbit not closed example, for BPM0650.

One variants of optics was used: the use of the sextupoles to correct the chromaticity. The logbook of these sessions is presented in the following table:

Session		Multi-turn	Kick	Sextupoles
Friday 17 July 2009	(A)	5/70/140	-	-
Friday 24 July 2009	(B)	35	✓	-
Tuesday 11 August 2009	(C)	13/70	✓	-
Thursday 13 August 2009	(D)	60 ⁹⁾	✓	✓

Table 1: Logbook of the data acquisition.

⁹⁾ Always with a kick in both directions.

5.2 Tune measurement

Multi-turn

Session	Turns	Horizontal tune	Vertical tune
(A)	5	0.75 ± 0.02	0.81 ± 0.01
	70	0.68 ± 0.01	0.769 ± 0.009
	140	0.69 ± 0.02	0.78 ± 0.01
(B)	35	0.693 ± 0.003	0.750 ± 0.002

Table 2: Horizontal and vertical tune for multi-turn configuration.

The maximum number of turns analysed is strongly limited by the decoherence effect, as shown in Fig. 11. After 40 turns, the damping is too important to still see the oscillations. From session (A), a number of turns too small can give a bad result for the horizontal and vertical tune, nevertheless a too high number can reduce the position acquisition accuracy, indeed the *BPMs* are not able to acquire an unlimited number of points, hence the sampling quality will be decreased. The optimal number of turns is between 40 and 70.

Horizontal and vertical kick

Session	Kick	Horizontal tune	Vertical tune
(B)	horizontal	0.71 ± 0.02	0.76 ± 0.02
	vertical	0.71 ± 0.01	0.750 ± 0.006
(D)	both	0.730 ± 0.006	0.78 ± 0.01

Table 3: Horizontal and vertical tune with a kick at the injection.

From session (B), the vertical orbit distortion is improving the tune accuracy, however not the horizontal one. The kick is necessary to avoid the closed orbit solution, but the kick alone is not sufficient for a high resolution measurement due to the strong damping maybe coming from uncorrected chromaticity.

Sextupoles

In the *CTF3* combiner ring, the optics with corrected chromaticity is not yet commissioned. There are three families of sextupoles, the family for the longitudinal chromaticity correction (L), the one for the horizontal chromaticity correction (H) and finally for the vertical chromaticity correction (V). Their settings have been found experimentally but they are still not perfect and have to be improved.

Session	L	H	V	Horizontal tune	Vertical tune
(D)	20 A	-20 A	0 A	0.71 ± 0.02	0.74 ± 0.03
	0 A	-40 A	40 A	0.773 ± 0.004	0.76 ± 0.01

Table 4: Horizontal and vertical tune for chromaticity correction by sextupoles.

As seen with the computer simulations in Sec. 4.2, chromaticity is an important issue for the tune determination. The add of the sextupoles in the *CTF3* combiner ring is improving the results. Setting sextupoles to $L = 0$ A, $H = -40$ A and $V = 40$ A, reduced clearly the decoherence hence gave chance for better vertical tune determination.

5.3 Phase advance measurement

The horizontal and vertical phase advance are also computed for the different sessions. The results for 70 turns and with the use of the sextupoles are presented in Figs. 19 and 20, and also compared to the model.

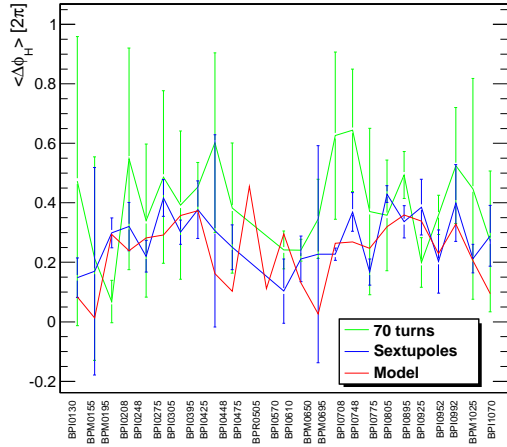

Figure 19: Horizontal phase advance for different configurations compared to the model.

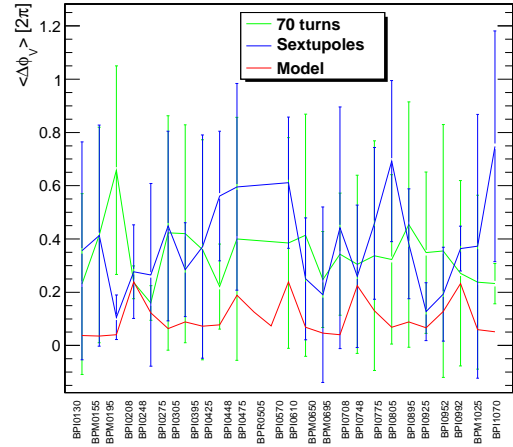

Figure 20: Vertical phase advance for different configurations compared to the model.

The errors are too large, however the use of the sextupoles clearly increases the accuracy in the horizontal plane. Indeed they enable to lower the damping, see Fig. 21. Therefore, a precise measurement really requires a good control of the chromaticity via the three sextupoles families present in the combiner ring layout.

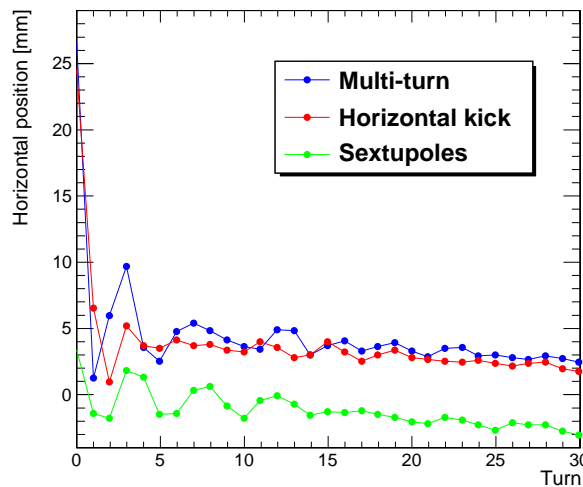

Figure 21: Horizontal position for the different configurations for BPI0130.

6 Conclusion

In order to study the *CLIC* feasibility, the *CTF3* test facility has been built at *CERN*. One of the most important part is the combiner ring to assemble the bunches, therefore its optics has to be well known and understood. Four measurement sessions have been performed to acquire experimental data from the combiner ring different *BPMs*. These raw data have been processed in order to extract the horizontal and vertical positions of the bunches for each turn to determine the ring tune Q and phase ϕ . The Sussix algorithm has been chosen among others here to analyse the data for the different ring configurations via frequency analysis. To improve the horizontal and vertical tune measurements accuracy, between 30 and 70 turns with an injection kick are necessary. Moreover, another major improvement to reduce the signal noise is the use of sextupoles to correct the chromaticity. Computer simulations with MAD-X have shown that even with $\Delta p/p$ following a Gaussian distribution with $\sigma = 0.5\%$, the signal is damped after only 10 turns without sextupoles. Other simulations have underlined the importance of the sextupoles, because theoretically one can obtain a better resolution on the tune determination. The *SVD* algorithm should be the best but it could not be applied to these data due to technical limitations. The possible improvements to obtain the ring optics functions are four:

- Use of sextupoles to eliminate chromaticity.
- Use of the *SVD* algorithm for the phase advance. It gives better results, closer to the model, however the Python script has to be upgraded to take into account the fact that all the *BPMs* do not acquire the same number of turns.
- Reduce the time acquisition of the data. This one can be very long if one of the servers, where the data from the *BPMs* are processed, is overloaded. This can be solved by using threads in the code to read these data in a parallel way.
- Average over many shots in order to improve error bars.

Acknowledgements

Pierre-Louis thanks people from the *CTF3* control room, Frank Tecker, Piotr Skowronski and Simona Bettoni for having taken time to set up the machine for his measurements and to have trusted him. He also thanks Thibaut Lefevre for his explanations about the *BPMs*. Finally, he likes to thank Roberto Corsini and Jean-Pierre Delahaye who welcomed and sponsored his stay at *CERN* to work on the *CLIC* test facility and Prof. Rivkin for his advices during these measurements.

Appendix

A Graphical User Interface

A Graphical User Interface (*GUI*) enables to acquire and analyse data from the *CTF3* combiner ring, see Fig. 22. First the button `Acquire` will run the acquisition script to get and save the current, the horizontal and the vertical position for each *BPM* and *BPI* in the `Raw/` folder. It is possible to store these raw data in an archive on *CASTOR* by providing a username. Then the processed window is selected by moving and resizing the slider, the revolution frequency is given by a *FFT*, this value can be modified. The `Processed` button will extract the turns and create a file in the `Processed/` directory with the same syntax than *MAD-X*. Finally these data can be analysed by the different algorithms¹⁰⁾, the tune and the phase advance are displayed and stored in the `Results/` repository.

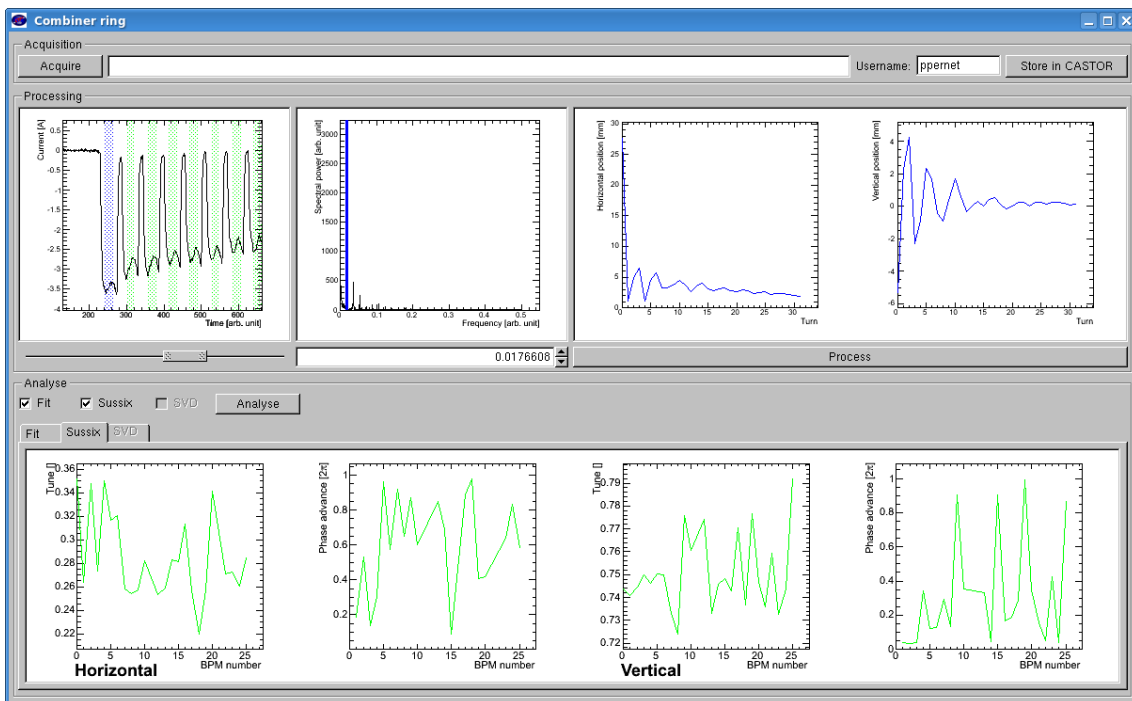

Figure 22: Screenshot of the Graphical User Interface.

¹⁰⁾ The *SVD* script is not available for the moment.

B List of the different BPMs and BPIs

The *BPMs* and *BPIs* of the combiner ring used for the different simulations, and for the data acquisition are the following:

BPI0130	BPI0305	BPI0570	BPI0775	BPM1025
BPM0155	BPI0395	BPI0610	BPI0805	BPI1070
BPM0195	BPI0425	BPM0650	BPI0895	
BPI0208	BPI0448	BPM0695	BPI0925	
BPI0248	BPI0475	BPI0708	BPI0952	
BPI0275	BPR0505	BPI0748	BPI0992	

Table 5: List of the combiner ring *BPMs* and *BPIs*.

References

- [1] **CLIC here for the future: “The Compact Linear Collider study aims for the high-energy frontier”**, Hans Braun, Jean-Pierre Delahaye, Albert de Roeck and Günther Geschonke, “*CERN Courier, Volume 48, Number 7, Sep 2008*”.
- [2] **CERN Document Server**, <http://cdsweb.cern.ch/collection/Photos?ln=en>.
- [3] **CTF3 Design Report**, CTF3 collaboration, “*CTF3 Note 2002-047*”.
- [4] **Handout of “Introduction to particles accelerators” course**, Leonid Rivkin, “*École Polytechnique Fédérale de Lausanne, fall semester 2008*”.
- [5] **CASTOR website**, <http://castor.web.cern.ch/castor/>.
- [6] **Root website**, <http://root.cern.ch/root/html/TGraph.html#TGraph:Fit>.
- [7] **Particle physics booklet**, Particle Data Group, “*LBNL and CERN, July 2008*”.
- [8] **SUSSIX: A Computer Code for Frequency Analysis of Non-Linear Betatron Motion**, R. Bartolini and F. Schmidt, “*CERN SL/Note 98-017 (AP)*”.
- [9] **Model-Independent Beam Dynamics Analysis**, J. Irwin, C. X. Wang, Y. T. Yan, K. L. F. Bane, Y. Cai, F.-J. Decker, M. G. Minty, G. V. Stupakov, and F. Zimmermann, “*Physical Review Letters, Volume 82, Number 8*”.
- [10] **PTC website**, http://mad.web.cern.ch/mad/ptc_general/ptc_general.html.