



CTF3-Note-102

RF phase stabilization in CTF3

Alexey Dubrovskiy, Frank Tecker
CERN, Geneva, Switzerland

Abstract

RF phase loops have been developed in order to improve the stability of the drive beam in CTF3 by keeping the RF phase locked in accelerating, bunching and deflecting cavities. The document describes the RF layout, the stabilization principle and the integration into the controls system. Illustrations of the RF phase loop performance are given.

Geneva, Switzerland

Jan 9, 2012

RF phase stabilization in CTF3

Alexey Dubrovskiy (`alex@solf.ru`)
Frank Tecker (`Frank.Tecker@cern.ch`)
CERN, Geneva, Switzerland

Jan 9, 2012

Abstract

RF phase loops have been developed in order to improve the stability of the drive beam in CTF3 by keeping the RF phase locked in accelerating, bunching and deflecting cavities. The document describes the RF layout, the stabilizing principle and the integration into the controls system. Illustrations of the RF phase loop performance are given.

1 Introduction

CTF3 is a test facility to demonstrate critical issues of the Compact Linear Collider (CLIC) [1, 2]. Prototypes of the main CLIC machine components are installed in the facility: the injector, the Linac, the delay loop, the combiner ring, the deceleration line and the two-beam setup. The facility is used for beam-based experiments in order to archive the CLIC design specification, to proof the reproducibility of the setup for a long-term run and to perform tests requiring stable beam conditions. The beam energy and the bunch length stability are strongly linked to the RF source stability in the injector and Linac [3]. Measurements showed that slow RF phase drifts have the major impact on the beam. In order to compensate them RF phase loops for high power RF sources have been developed, which allow locking the RF phases [4].

2 RF phase acquisition and control

All pulsed high power RF sources are equipped with RF phase acquisition and control systems in CTF3. These systems allow to monitor, to control and to lock the phase of the high power RF at the input or output of RF cavities of the beam line. Three different types of RF layouts are used for:

- Sub-harmonic bunching systems,
- Bunching system,
- Accelerating and deflecting cavities.

In all these cases the RF phase is adjusted individually for each RF source by a phase shifter. The global RF phase adjustment is done by operators once during the setup of the machine. The RF phase of the distributed carrier signal is supposed to be significantly more stable than phase variations of the high power RF owing to the thermal variation of RF waveguides and RF compressors.

2.1 Sub-harmonic bunchers

Three Sub-harmonic RF bunchers (SHB) are installed just after the thermionic electron gun: *SHB01*, *SHB02* and *SHB03*. Their function is to provide the beam phase coding at 1.5 GHz, which is required for the beam recombination factor eight in the Delay loop and the combiner ring. It is very important to keep the RF phase locked in order to provide the beam bunching at a high quality and to reduce undesired presence of beam satellites. Each SHB is powered by a traveling wave tube (TWT), which amplifies the carrier signal up to a few tens of kWatts. Directional couplers used for the loop are installed at the output of each SHB. The phase of the transmitted RF represents the phase seen by the beam and it is controlled by a phase shifter of the carrier signal (Fig. 1). Since the RF pulse length of TWT is longer than the beam pulse length it is always possible to choose a range of the RF pulse, which is not effected by the beam loading. Hence the phase can be locked even when the beam is present.

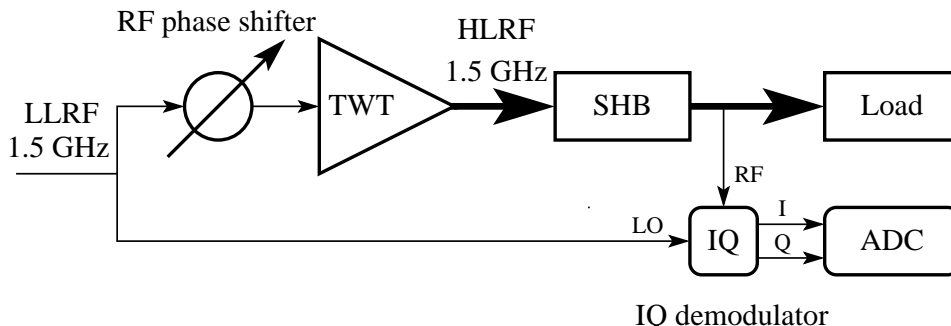

Figure 1: Layout of the SHB RF phase acquisition and control.

2.2 Bunching system

The pre-buncher and buncher RF cavities are powered by one common klystron *MKS02* (Fig. 2). The high power RF splitter defines the ratio between the power feeding the pre-buncher and buncher. The carrier RF phase shifter and high power RF phase shifter allow to individually adjust RF phases with respect to the beam coding and thereby it defines the beam phase. Long waveguides and the high power RF phase shifter change the transmitted RF phase differently for two RF lines, when the ambient temperature varies. The buncher RF phase is locked at the input of the buncher cavity by acting on the carrier phase shifter, the pre-buncher is adjusted at the same time. The fine pre-buncher RF phase adjustment is done by acting on the high power phase shifter in order to obtain the desired RF phase at the input of the pre-buncher cavity.

2.3 Drive beam acceleration

Each of eight klystrons feeds two accelerating structures in CTF3. The layout of the acquisition and control of the RF phase is similar for these klystrons (Fig. 3). The high-power RF phase is controlled by a low-level RF phase shifter. The RF phase pick-up is normally taken at the input of one of the accelerating structures. The phase error at the second accelerating structure should be the same. A strong RF phase change comes from the RF compressors installed after the klystrons and long waveguide systems. Phase loops compensate slow phase variations averaged over the flat-top of the RF pulse.

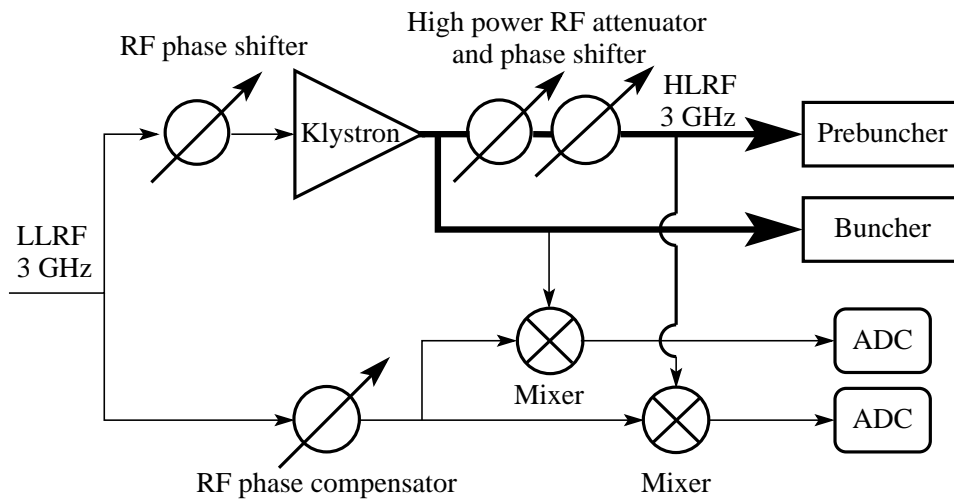

Figure 2: Layout of the buncher RF phase acquisition and control.

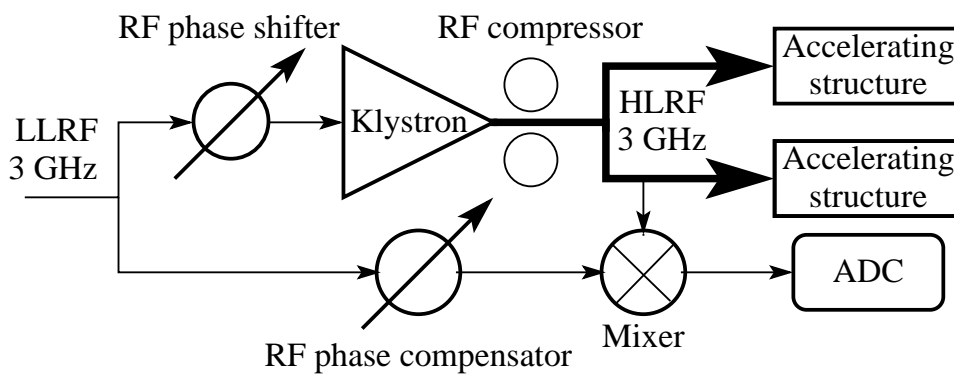

Figure 3: Layout of the klystron RF phase acquisition and control.

3 RF phase stabilization

3.1 Phase loop layout

The general phase loop layout is illustrated in Fig. 4. In most of the cases there are two phase shifters installed: one to shift the high power RF phase and the other one is to adjust the phase acquisition measurement. The last one is called the phase compensator. In the case of the pre-buncher and sub-harmonic bunchers the acquisition adjustment is not used.

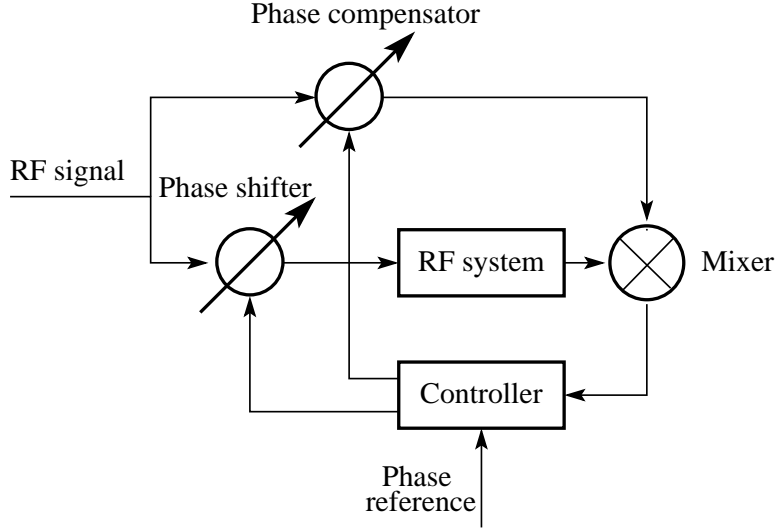

Figure 4: RF phase loop.

An ideal phase detector based on a mixer gives at the output a DC signal of the difference of RF and low level carrier signals:

$$V_{IF} = \pm 2A_{lo}A_{rf} \cos(\phi_{err} + \phi_{sh} - \phi_{comp} + \pi),$$

where A_{lo} is a constant amplitude of the carrier signal, A_{rf} is the RF amplitude, ϕ_{sh} is the RF phase shift given by the phase shifter, ϕ_{comp} is the RF phase shift given by the phase compensator and ϕ_{err} is a high power phase error. The RF amplitude A_{rf} is measured and the amplitude of the carrier signal is calibrated. Therefore the phase difference is explicitly measured as following:

$$\Delta\Phi = \phi_{err} + \phi_{sh} - \phi_{comp} = \pm \arcsin \frac{V_{IF}}{2A_{lo}A_{rf}}.$$

The phase difference can be determined only in the range of $[-\frac{\pi}{2}; \frac{\pi}{2}]$. That's why the phase measurement based on a mixer can not be used as a global reference. Moreover in the real setup the measurement of phase difference is linear only the phase difference is near zero. Therefore the phase compensation is tuned in a way to get $V_{IF} \approx 0$.

When the phase error is relatively small and the phase shifters are calibrated the global phase reference can be defined as following

$$\Phi_{ref} = \phi_{ref} + \phi_{sh} - \phi_{comp},$$

where ϕ_{ref} is the phase acquisition at the reference position. Normally, the global phase reference is defined at zero $\Phi_{ref} = 0$.

The phase reference is defined by the users. Once the reference is changed the phase compensator is adjusted in order to bring the phase measurement back close to the reference. Hence the stabilization procedure consists of two stages:

1. Setup the phase compensator in order to read the acquisition phase as close as possible to the phase reference. It is done by changing the phase compensator iteratively in order to minimize $|\phi_{err} - \phi_{ref}|$.
2. Keep the difference $|\phi_{err} - \phi_{ref}|$ as small as possible by adjusting the phase shifter. Only at this stage the thermal drifts are compensated.

3.2 Stabilization method

The phase stabilization algorithm is based on the exponential moving average (EMA) filter at a fix sampling rate of the basic period of $0.8Hz$:

$$ema_t = \frac{n-1}{n}ema_{t-1} + \frac{1}{n}p_t,$$

where p_t is the phase measurement at a time t , ema_t is the EMA and n is the filter parameter. A feedback based on the EMA filter guarantees global stability for any filter parameter and the maximum frequency amplification is only a few percent. The performance of an ideal one-to-one feedback based on the EMA filter is shown in Fig. 5. The day-night variations are suppressed by the order of between -42dB (0.007%) and -22dB (0.6%).

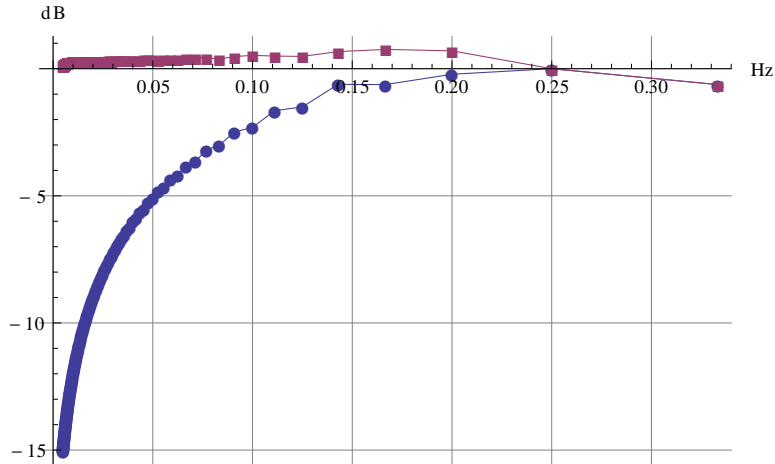

Figure 5: Loop-gain magnitude versus frequency at the sampling rate of 1Hz. The blue line shows the best performance and the red line shows the worst performance.

The performance of the RF loop at different parameters n is illustrated in Fig. 6, where a measured phase spectrum was used, delays and the discrete phase change were taken into account. Simulations showed that the best performance is archived for parameters n between 15 and 30. The parameter n can also be chosen upto 150 with a small degradation in performance (20%). Choosing higher n leads to a less frequent adjustment of the phase shifter. And therefore the control loop does not introduce high frequency fluctuations (0.2-0.5 Hz), which are undesirable for beam pulse-to-pulse measurements. The RMS of the expected residual global phase variation is between 0.6 and 1.2 deg.

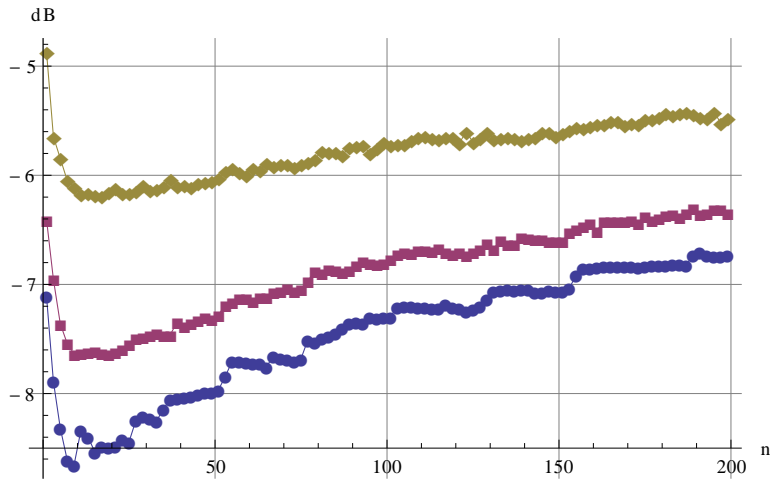

Figure 6: Loop-gain magnitude versus EMA parameter n at different levels of a high frequency noise: blue points - 0.05 deg, red points - 0.5 deg and yellow points - 1 deg.

4 Software specification

4.1 Implementation and Deployment

The phase stabilization of the RF phase loop has been developed in the FESA framework:

- The class name is **RFPhaseLoop** and the current version is **210**;
- The source code of the FESA class is available in the CERN CVS system:
<http://isscv.s.cern.ch>.

The communication to the phase movers and the RF phase acquisition are implemented through the CMW-RDA interface. The integration diagram is shown in Fig. 7, where the phase loop FESA application runs on **cs-ccr-ctf1** and the task name is **RFPhaseLoop_M**. The equipment relations are listed below:

<i>RFPhaseLoop</i>	<i>RFMKSKLY</i>	<i>XenericSampler</i>
CK.MKS02-PBU-LOOP	CK.PBU0245-PHAS	CK.SVPPBEI2P
CK.MKS02-LOOP	CK.LL-MKS02	CK.SVPBEIP
CK.MKS03-LOOP	CK.LL-MKS03	CK.SVPSI03P
CK.MKS05-LOOP	CK.LL-MKS05	CK.SVPSI05P
CK.MKS06-LOOP	CK.LL-MKS06	CK.SVPSI06P
CK.MKS07-LOOP	CK.LL-MKS07	CK.SVPSI07P
CK.MKS11-LOOP	CK.LL-MKS11	CK.SVPSI11P
CK.MKS12-LOOP	CK.LL-MKS12	CK.SVPSI12P
CK.MKS13-LOOP	CK.LL-MKS13	CK.SVPSI13P
CK.MKS15-LOOP	CK.LL-MKS15	CK.SVPSI15P
CK.MKL02-LOOP	CK.LL-MKL02	CK.SVPSIL02P
CK.MKS14-LOOP	CK.LL-MKS14	CK.SVPSI14P

4.2 Algorithm

The RF phase analysis and corrections are implemented in the RT task. The logic of the RT task is illustrated in Fig. 8. The status of the device depends on the mode. Two different fault statuses are possible: the error status normally indicates an unrecoverable problem and

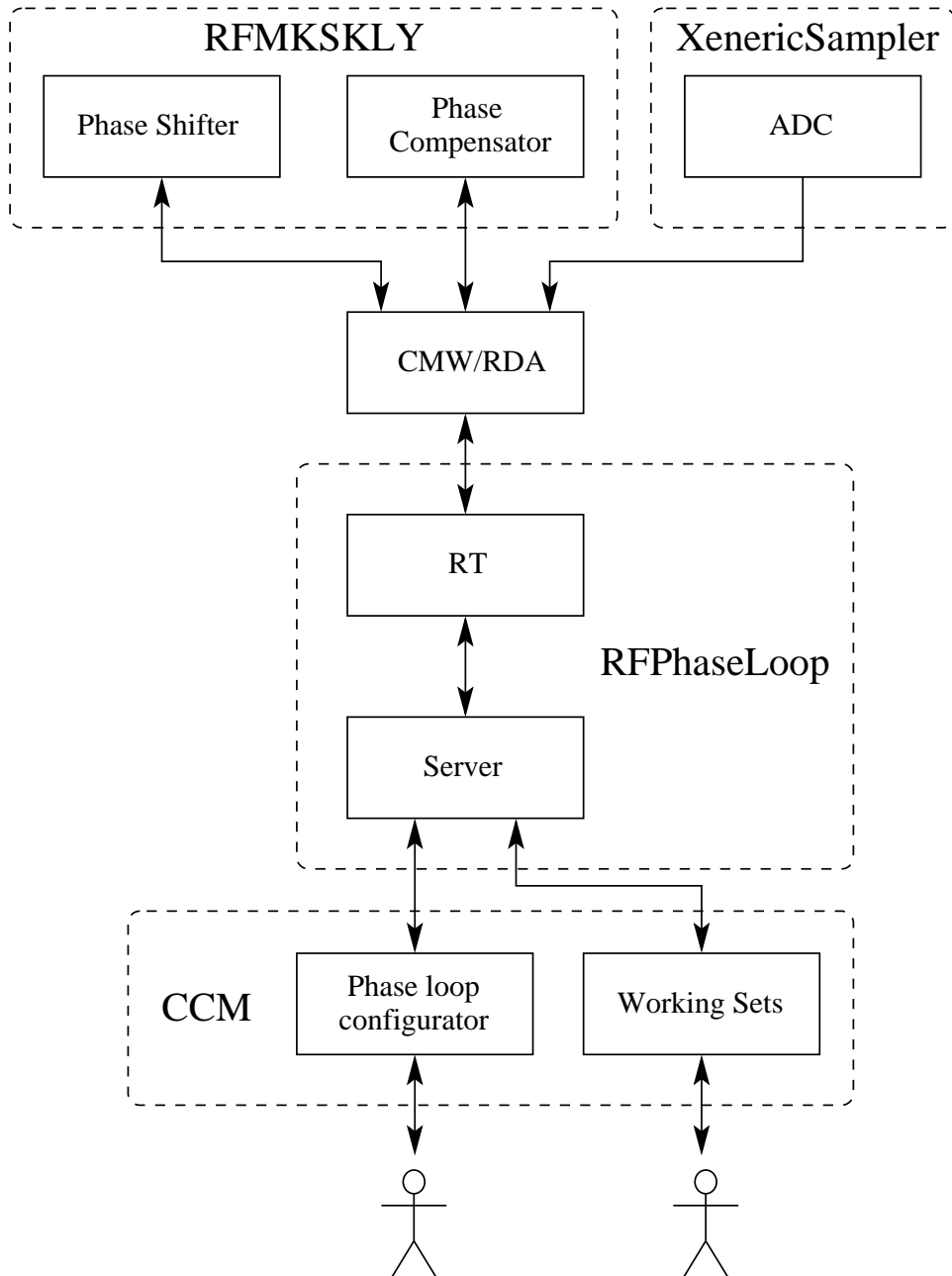

Figure 7: RF phase loop deployment diagram.

the warning status normally indicates a temporary problem or missing acquisition data. The set of enabled functions depends on the mode of operation:

<i>Function / Mode</i>	NONE	OFF	STANDBY	CALIBRATION	STABILIZATION	ON
Phase acquisition			X	X	X	X
Phase stabilization					X	X
Phase compensation				X		X

Only the following combinations of modes and status are possible:

<i>Status / Mode</i>	NONE	OFF	STANDBY	CALIBRATION	STABILIZATION	ON
NONE	X					
OK		X	X	X	X	X
WARNING		X	X	X	X	X
ERROR			X	X	X	X
CALIBRATION						X

The sequence of actions required to change the RF phase reference is illustrated in Fig. 9.

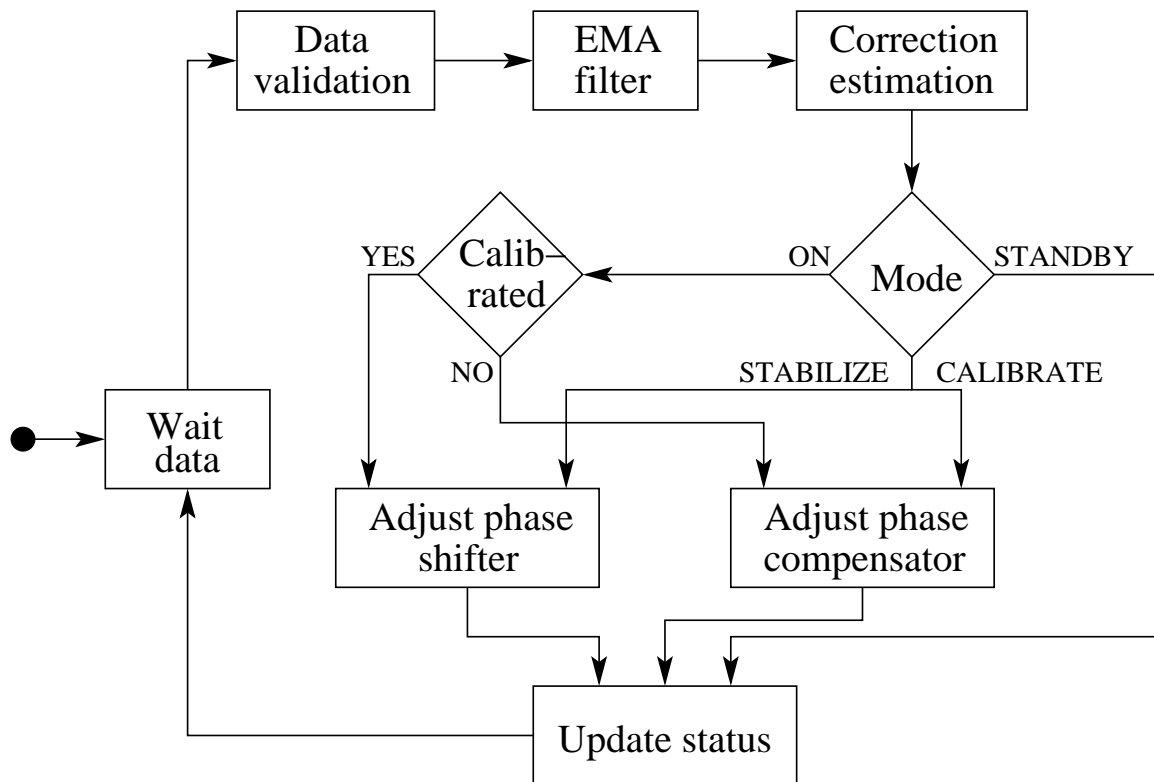

Figure 8: Algorithm of the RF phase loop.

4.3 Remote access interface

The communication interface with the phase loop controller is provided by the FESA server through the CMWRDA interface. The main device properties are:

- **Acquisition** - the set of the main acquisition parameters:

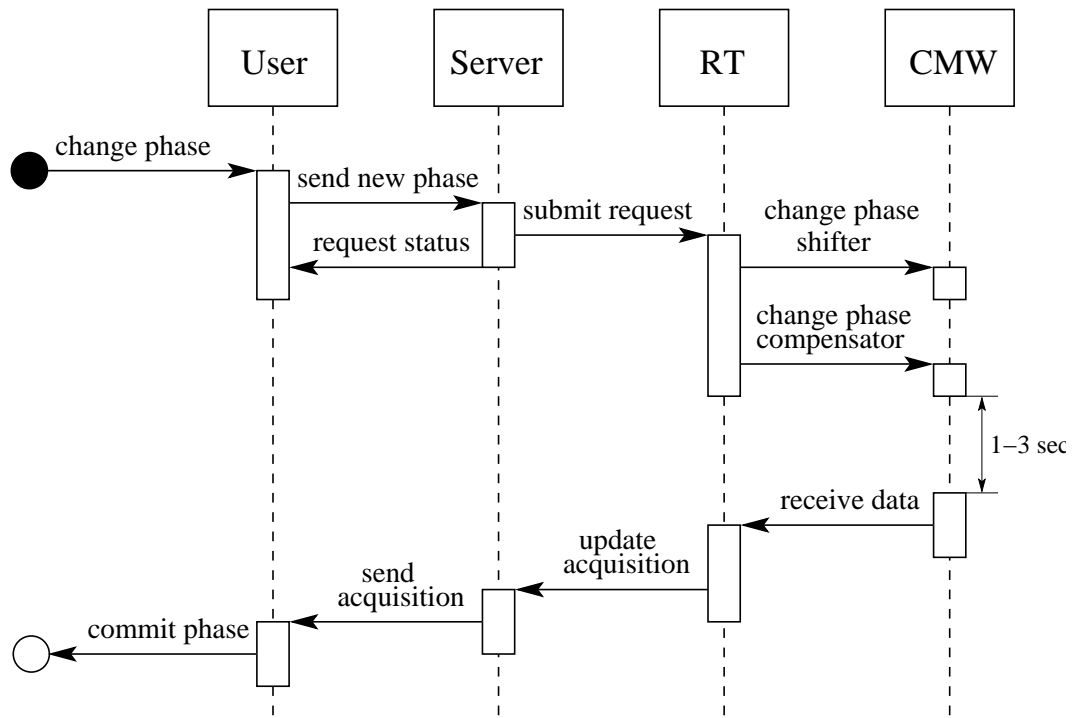

Figure 9: RF phase reference change diagram.

Field name	Type	Description
acqStamp	64-bit integer	The acquisition time stamp
calibrated	boolean	The indication if the phase measurement has been calibrated by the phase compensator
compShifter	double	The acquisition position of the phase compensator
expAvg	double	The current EMA value
expAvgPulseNum	integer	The number of pulses used to calculate EMA
klystronShifter	double	The acquisition position of the phase shifter
mean	double	The acquisition phase averaged over the flat-top

- **Mode** - the mode of the device:

Field name	Type	Description
mode	enum	The mode of the device

- **PhaseShifterControl** - the phase control:

Field name	Type	Description
value	double	The phase control value
value_max	double	The maximum phase control value
value_min	double	The minimum phase control value

- **Setting** - the main settings:

Field name	Type	Description
autoRestoreMode	boolean	If true the device mode is set automatically after the reboot to the latest operational mode
compShifterStep	double	The minimum phase compensator step
klystronShifterMean	double	The mean phase value of the range of the permitted phase adjustment
klystronShifterMeanAuto	boolean	If true the value <i>klystronShifterMean</i> is set automatically
klystronShifterRange	double	The width of the range of the permitted phase adjustment
klystronShifterStep	double	The minimum phase shifter step
phaseAcquisitionOffset	double	The additional acquisition phase offset, normally it equals to zero
phaseActiveThreshold	double	The minimum phase error to be adjusted
phaseExpAvgPulseNumMin	integer	The EMA <i>n</i> parameter
phasePassiveThreshold	double	The maximum phase error to be adjusted

- **Status** - the status of the device:

Field name	Type	Description
mode	enum	The acquisition device mode
status	enum	The acquisition device status
statusTime	double	The duration in seconds of the current status

4.4 Instantiation of new devices

The following final fields must be specified during the instantiation of new devices:

Field name	Type	Description
cycleSelector	string	The cycle selector
eqpCompPhaseShifter	string	The phase compensator device name
eqpCompPhaseShifterType	enum	The phase compensator device class
eqpKlystronPhaseShifter	string	The phase shifter device name
eqpKlystronPhaseShifterType	enum	The phase shifter device class
eqpKlystronPhase	string	The phase acquisition device name

4.5 Graphical Phase Control

The graphical access interface to the RF phase loop devices is implemented through the standard CERN control system. The configuration name is

CTF3OP

All RF phase loop devices were declared in one group in *WorkingSets*:

WorkingSets → *RF* → *CTF:RF+BUNCHING*

Control knobs allow to control the phase and to see the acquisition phase and status for each loop (Fig. 10a).

4.6 Graphical Configuration

The configuration GUI for the RF phase loops can be launched from *CCM* for *CTF3OP*:

CCM → *TEST* → *RF Phase Loop*

The application allows to display the main properties and to define the main parameters (Fig. 10b). The acquisition RF phase cursor and interval can be configured in the phase settings panel. The control knobs are placed in the environment panel.

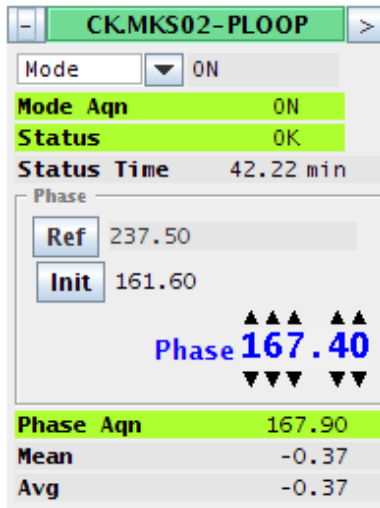

(a) Controls Knob

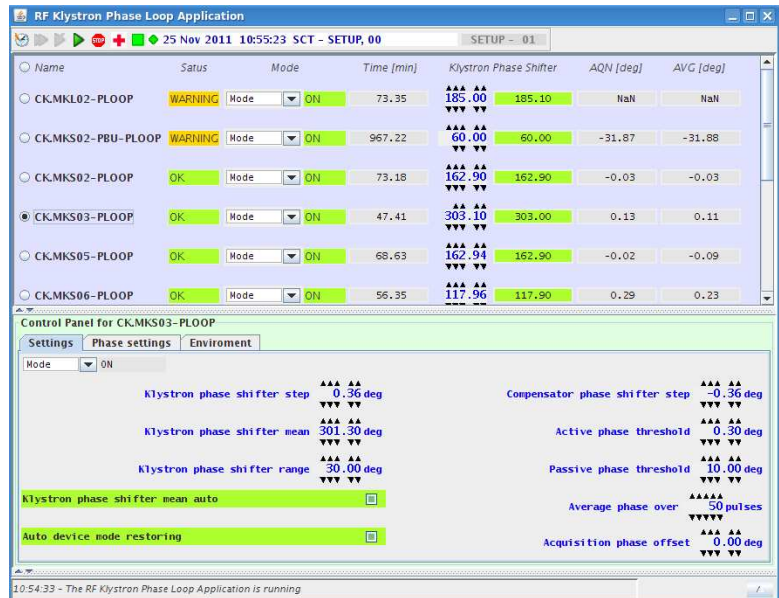

(b) Configuration application

Figure 10: RF phase loop GUI.

5 Conclusions

RF phase loops have been developed, implemented and integrated into the CERN control system for all high-power RF sources in CTF3. Loops are used in the daily machine operation, which significantly improved the beam stability and the operability. And it proved itself as efficient, reliable, user-friendly and fault-tolerant systems. The author suggests his inquiring readers to go through the appendix material and to see the orders of the phase compensation and stabilization.

References

- [1] G. Geschonke et al. CTF3 Design Report. Technical Report CTF3 Note 2002-047, CERN, May 2002.
- [2] G. Geschonke et al. A 3 TeV e^+e^- Linear Collider Based on CLIC Technology. Technical Report 2000-008, CERN, July 2000.
- [3] D. Schulte and et al. Status of the CLIC phase and amplitude stabilisation. Tsukuba, September 2010. LINAC10.
- [4] Alexey Dubrovskiy. RF phase and amplitude stability of the CTF klystrons. CERN Indico, February 2009. CLIC beam physics meeting.

A Illustration of the RF phase stabilization

A.1 MKS03

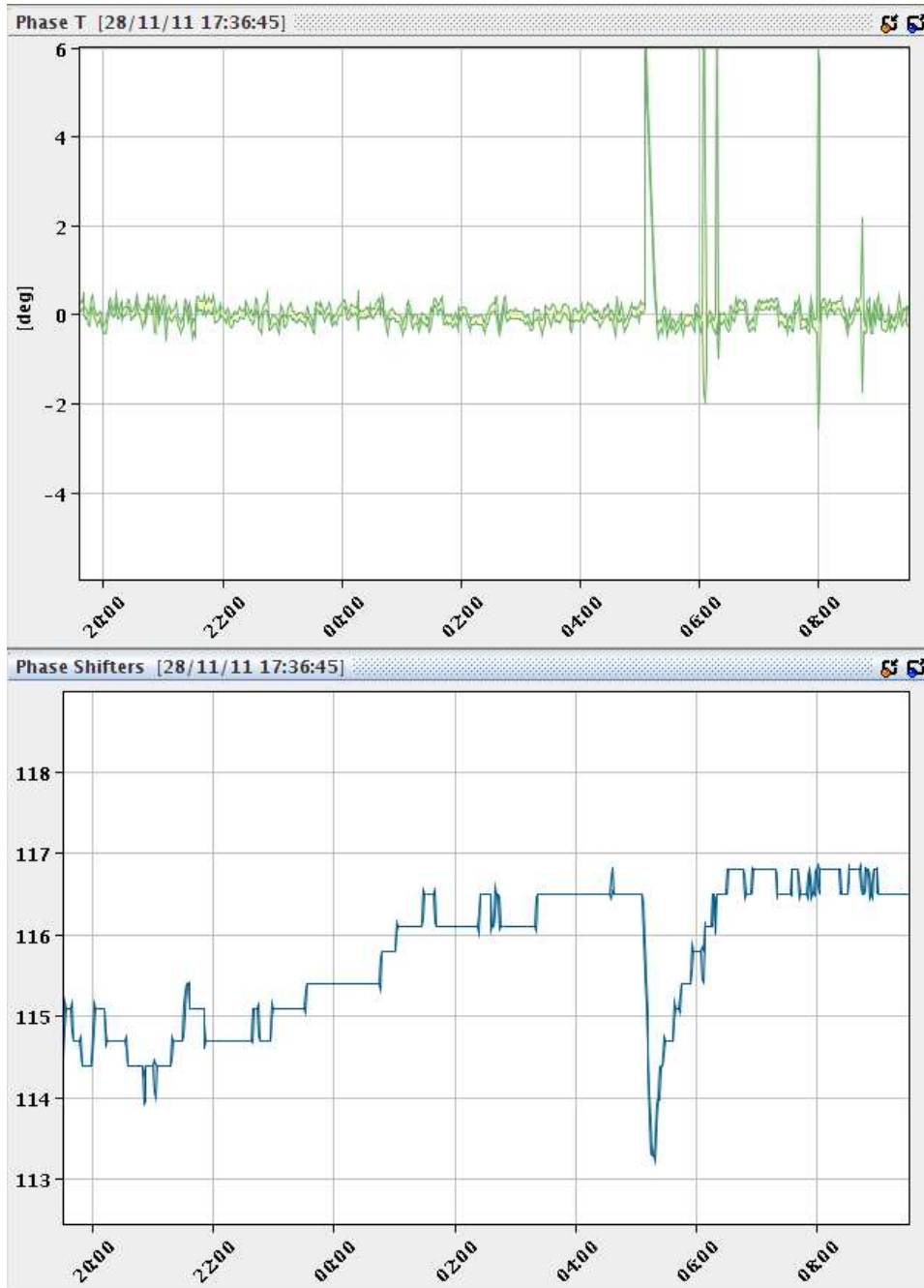

- The EMA parameter $n = 50$;
- The compensated variation $\Delta\phi = 2.5$ deg;
- The residual variation $\Delta\phi = \pm 0.2$ deg;
- The residual high frequency variation $\sigma(\phi) = 0.07$ deg.

A.2 MKS05

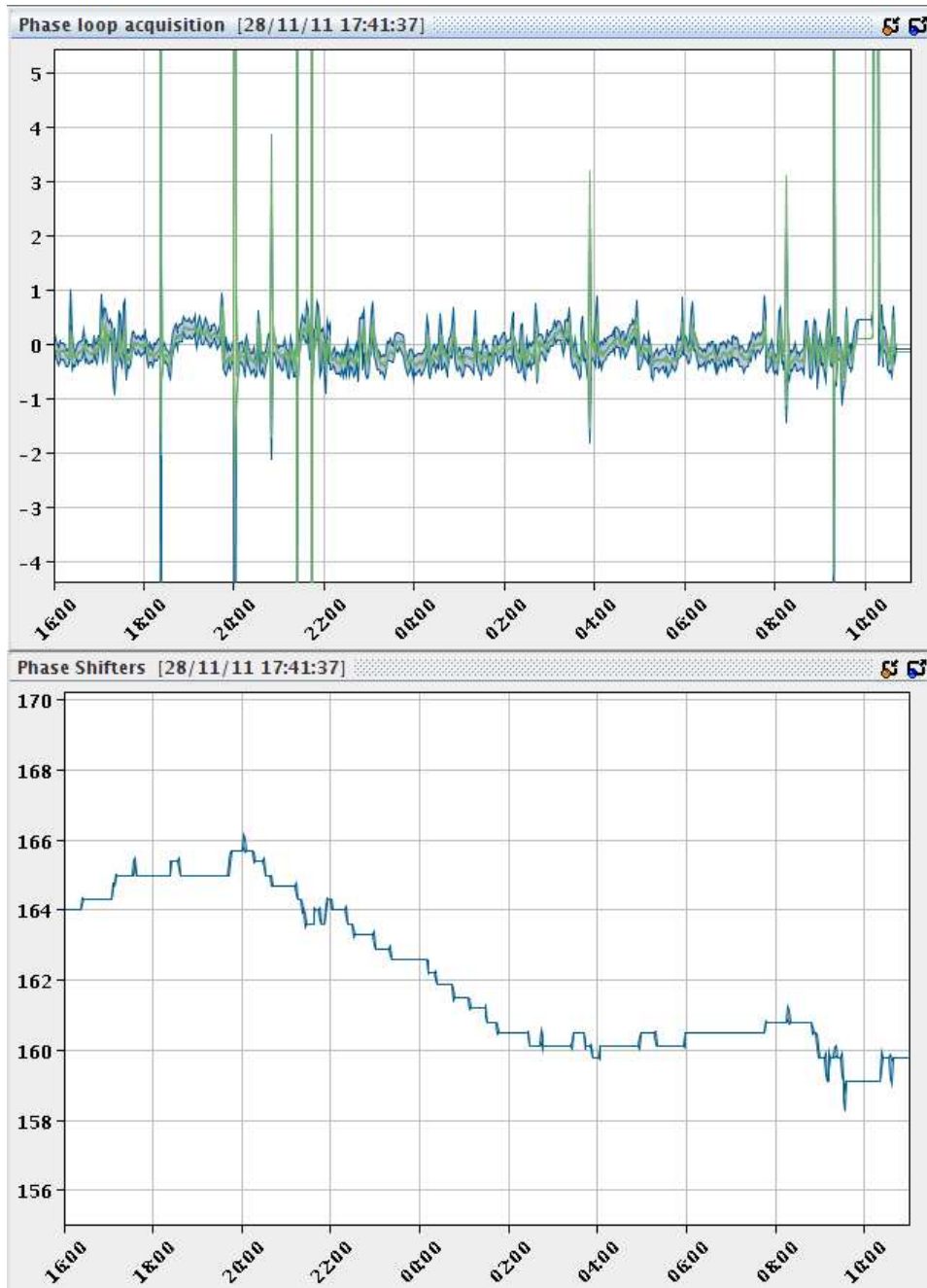

- The EMA parameter $n = 90$;
- The compensated variation $\Delta\phi = 7$ deg;
- The residual variation $\Delta\phi = \pm 0.4$ deg;
- The residual high frequency variation $\sigma(\phi) = 0.02$ deg.

A.3 MKS07

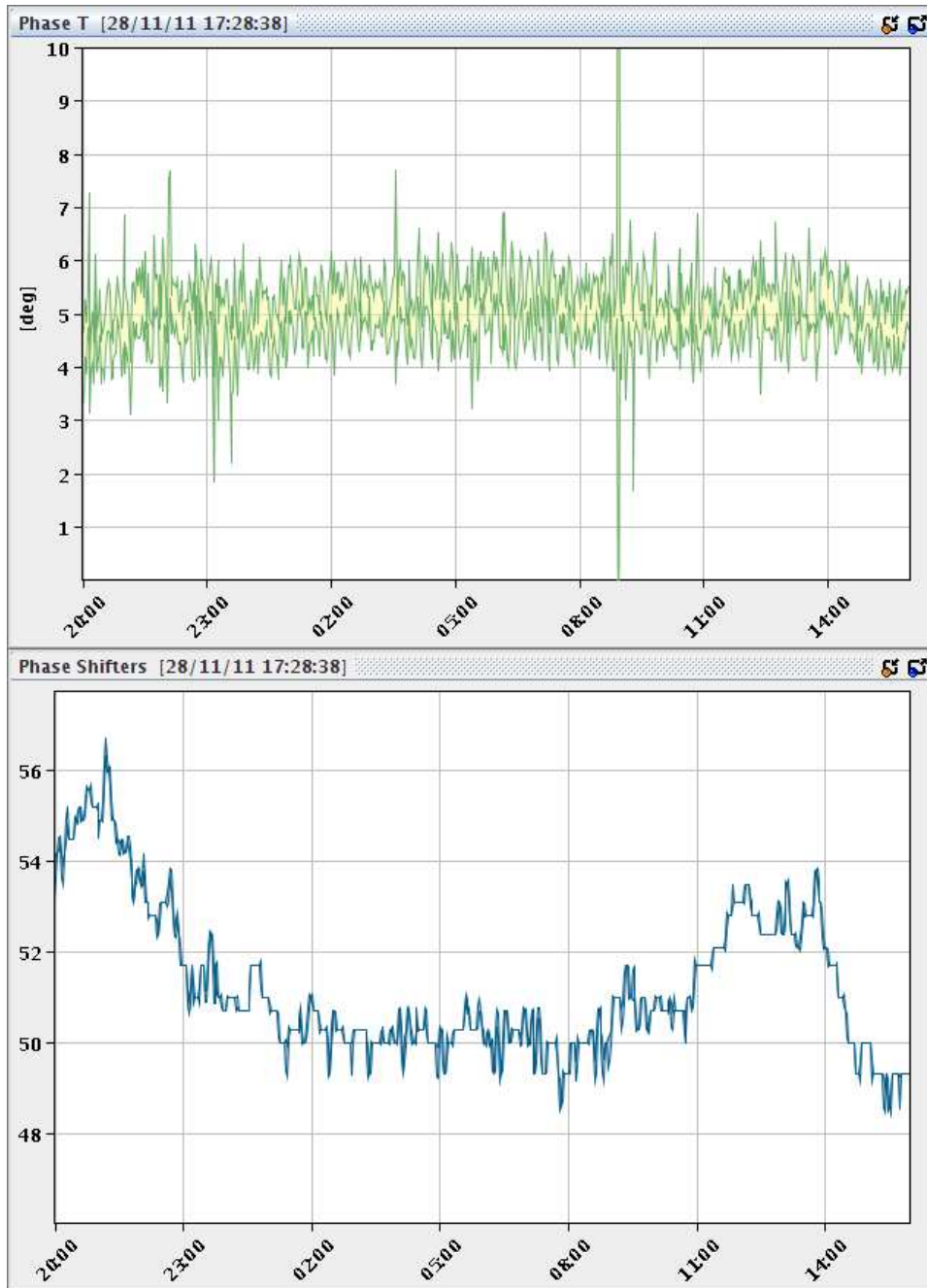

- The EMA parameter $n = 40$;
- The compensated variation $\Delta\phi = 8$ deg;
- The residual variation $\Delta\phi = \pm 0.6$ deg;
- The residual high frequency variation $\sigma(\phi) = 0.3$ deg.

A.4 MKS13

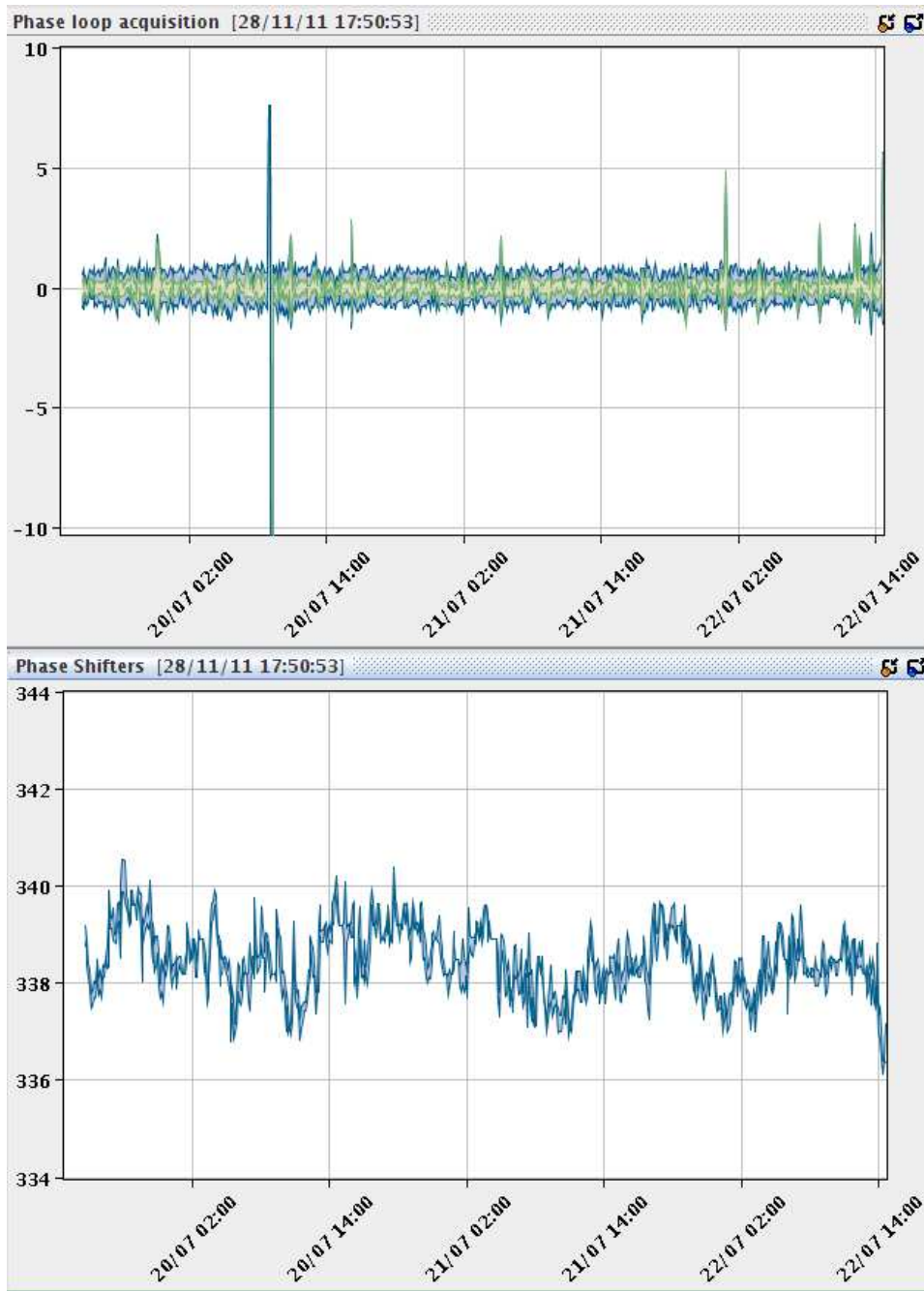

- The EMA parameter $n = 30$;
- The compensated variation $\Delta\phi = 4$ deg;
- The residual variation $\Delta\phi = \pm 0.4$ deg;
- The residual high frequency variation $\sigma(\phi) = 0.25$ deg.