

CTF3-Note-104

EDMS No. 1215630

Experimental Results at the C.E.R.N. Photoemission Laboratory with Co-deposition Photocathodes in the Frame of the CLIC Studies

E. Chevallay

Abstract

This note aims to review the work done in the Photoemission Laboratory during the last decade, before the end of the former CTF2 (CLIC Test Facility 2) up to spring 2012. The emphasis will be given on the photocathode studies in the so-called co-evaporation (or co-deposition) mode. The results achieved with Cs_2Te photocathodes will be presented and the preliminary results with Cs_3Sb photocathodes will be highlighted.

Geneva, Switzerland

May 2012

1. Introduction

Early in the CLIC (Compact Linear Collider) [1] [2] [3] studies, Y. Baconnier identified that the photoemission will be the physical process which can fulfill the drive-beam electron source requirements for the CTF (CLIC Test Facility) and which might be a good candidate for a CLIC source [4]. This electron source, so-called photoinjector, consists of three elements which must work in close synergy:

- The photocathode (Fig. 1), which is a photoemissive thin coating deposited on a substrate
- The laser, which illuminates the photocathode with an adequate light for producing the electrons
- The (DC or RF) gun, which provides the electric field to extract and accelerate these particles.

This note describes the photocathode itself, other papers report on the work performed on the RF gun [5] and the laser [6] [7] [8].

2. Historical background

The photoemission laboratory was founded in 1989 by Y. Baconnier, JHB. Madsen and G. Suberlucq [9] [10]. G. Suberlucq lead the laboratory [11] [12] [13] for more than 15 years with the goal to study electron sources for producing short pulses and high-intensity electron beams in the frame of the CLIC study. After a few years of initial R&D, this source has supplied routinely electrons in the day-to-day operation of the CTF2 facility during ~10 years [14].

Later, in the frame of the European program FP6/CARE/PHIN, a study was launched with the aim to fulfill the requirements for the next CLIC facility source, namely CTF3 [15], with a photoinjector, so-called PHIN [16] [17]. Today, the photoinjector specifications are mostly met [18] and the activities have shifted towards the evaluation of the feasibility of this technology to reach the parameters for the CLIC drive-beam source.

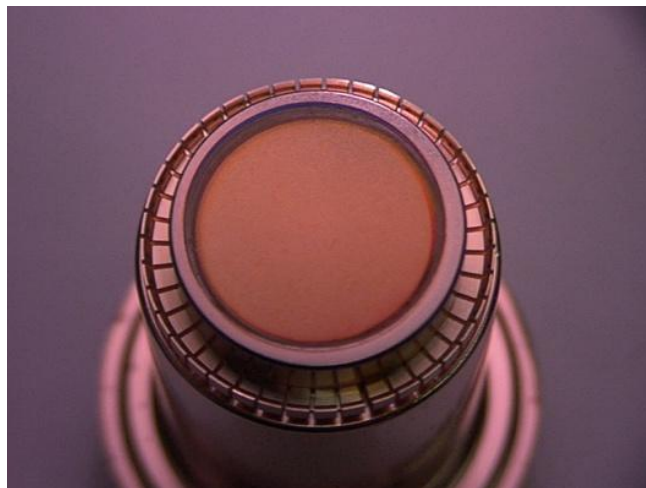

Figure 1: A Cs₂Te photocathode, the circular photoemissive coating is visible on the head

3. Definitions and Photocathodes Properties

The main property of photocathodes is the quantum efficiency (QE), which expresses the capability of this cathode to produce a certain current of electrons under a given photon flux, which is defined by:

$$QE = \frac{\text{Number of electrons}}{\text{Number of photons}}$$

In practice, the beam charge Q, the laser energy E and the wavelength λ are measured in nC, uJ and nm, respectively. The number of electrons and photons are calculated by the equations:

$$\text{Number of electrons} = \frac{Q[\text{C}]}{1.6 \times 10^{-19}[\text{C}]}$$

$$\text{Number of photons} = \frac{E[\text{J}]}{h[\text{J.s}] \times \nu[1/\text{s}]} = \frac{E[\text{J}]}{h[\text{J.s}] \times (c[\text{m/s}] / \lambda[\text{m}])} \quad \nu \text{ is the frequency}$$

$h = 6.626 \times 10^{-34}$ J.s the Plank's constant and $c = 2.998 \times 10^8$ m/s the light velocity.

This yields the following equations for the QE:

$$QE [\%] = \frac{124 \times Q[\text{nC}]}{\lambda[\text{nm}] \times E[\text{uJ}]} \quad \text{or} \quad QE [\%] = \frac{124 \times I[\text{uA}]}{\lambda[\text{nm}] \times P[\text{mW}]}$$

Additional parameters must be taken in consideration to fully characterize the properties of the photocathodes as summarized in Table 1.

Parameters	Typical Value	Unit
Cathode Type	Cs ₂ Te	-
Substrate Type	Cu	-
Max. Quantum Efficiency	> 20	%
Max. Single Pulse Charge	100 (at least)	nC
Mean Current	1 (at least)	mA
Life Time (with Qe > 3%)	> 300	Hours
Working Laser Wavelength	< 270	nm
Max Electric Field	<= 120	MV/m
Dark Current	~Idem copper	pA
Working Vacuum Pressure	< 10 ⁻⁹	mbar
Relaxation Time	< 3	ps

Table 1: Photocathode properties of Cs₂Te

- Cesium Telluride (Cs_2Te) is the chemical compound of the photoemissive alloy which is able to produce electrons when it is illuminated by ultra-violet (UV) light. Other alloys exist with different properties.
- The substrate type (e.g. copper) is of some importance for the Cs_2Te alloy. It seems that a copper substrate assists the thin coating to survive in a high RF electric field by improving its adherence, because a fraction of Te migrates in the copper bulk [19]. In addition, the substrate (Cu, Mo, etc...) has an influence on the value of the initial QE.
- The maximum single pulse charge is the maximum charge (or the maximum number of electrons) which can be extracted in one bunch (micro-pulse) of 10 ps. This number is a function of the laser energy, the electrical field and the laser beam size applied on the photocathode [20].
- The maximum mean current is the equivalent maximum DC (or CW) current extractable from the cathode.
- The life time is the time during which the cathode is able to produce the nominal charge with the nominal (or less) laser energy. Afterwards, the QE becomes too low and the photocathode must be exchange with a new one. The decay of the lifetime can be represented as the sum of two exponentials with a fast and slow decay:

$$\text{QE} = \text{QE1} \times e^{-\frac{t}{\tau1}} + \text{QE2} \times e^{-\frac{t}{\tau2}}$$

- $\tau2$ of the slow decay is the useful time constant for defining the life time of the photocathode as an exponential law.
- The laser wavelength needed to produce the electrons is linked to the type of photoemissive alloy. The Cs_2Te alloy requires a laser wavelength in the UV range.
- The substrate and its coating (e.g. the photocathode) must be operated under a high RF electric field. The combination of a copper plug and Cs_2Te alloy works up to a maximum of 120 MV/m as demonstrated at CTF2 [12] [21].
- The dark current of Cs_2Te photocathode is comparable to the one of the copper substrate itself [22].
- The photocathode desorption has to be low to avoid a strong outgassing in the ultra-high vacuum (UHV) vessel and was never measured. Nevertheless, if the cathode with its coating is inserted in or removed from a vessel with a pressure of 6×10^{-12} mbar, no significant change can be seen on the precision gauge. Therefore, the desorption is not an issue for the application described in this paper.
- The relaxation time must be smaller than the bunch length, which is ~ 8 ps fwhm for the RF photoinjector. It was measured in the CTF2 machine [12] and was found to be lower than 3 ps. (The measurement was limited by the instrumentation resolution).

4. Installations for Photocathode Production and R&D at CERN

4.1. The Photoemission Laboratory Experimental Setup

The experimental setup (Fig. 2) is built around three elements which are the work horses for the fabrication and the tests of the photocathodes:

- The preparation chamber,
- the DC gun and the measurement line,
- an industrial pulsed Nd:YAG laser.

During a first phase, the photocathode coating is growing inside the preparation chamber under ultra high vacuum conditions, by deposition of a thin film of an alloy of cesium and tellurium. At the same time, an electron beam is produced and collected by illuminating the photocathode with UV light for monitoring the quantum efficiency during the coating.

In a second phase, the photocathode is transferred with a manipulator under UHV vacuum conditions into the DC gun. An electric field is applied and the photocathode is illuminated with UV light for producing an 80 keV electron beam, which is monitored in the beam measurement line. This installation is the key point of the lab, which gives the possibility to measure the cathode performance with a real beam.

Finally, an additional mobile transport carrier (not visible on Fig. 2) offers the possibility to supply the PHIN RF photoinjector [17] with a batch of four photocathodes. The PHIN photoinjector itself is the real test bench where all the properties of the photocathodes can be monitored and measured under CTF3 beam conditions.

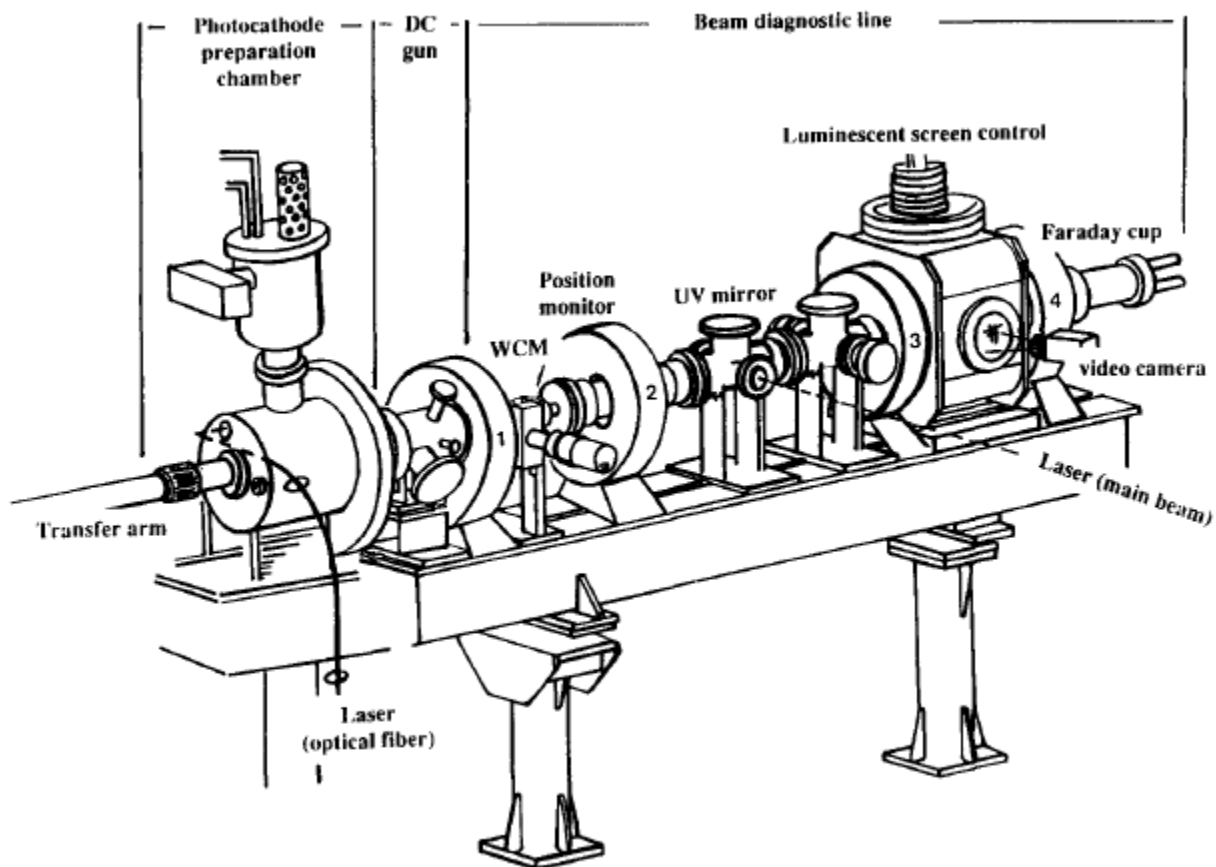

Fig. 1. The dc test bench.

Figure 2: A simplified sketch of the photoemission laboratory experimental setup

4.2. The PHIN RF Photoinjector

The PHIN photoinjector [17] is an off-line electron source test stand in the frame of the CTF3 studies (Fig. 3). It was designed and studied as an option for replace the CTF3 drive-beam thermo-ionic gun. It is the main client of the photoemission laboratory for using the photocathodes.

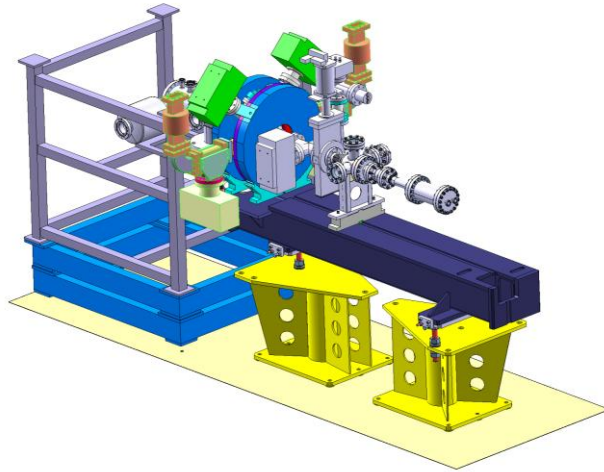

Figure 3: The PHIN RF Photoinjector test bench (Beam measurement line incomplete)

4.3. The CALIFES RF Photoinjector

The CALIFES (Concept d'Accélération Linéaire par Faisceau d'Electrons Sonde) photoinjector is the probe-beam [23] source (Fig. 4) for the regular operation of the two beam acceleration (TBA) scheme in the CTF3 complex. It uses Cs_2Te photocathodes produced in-situ in blind mode, see 5.4.2

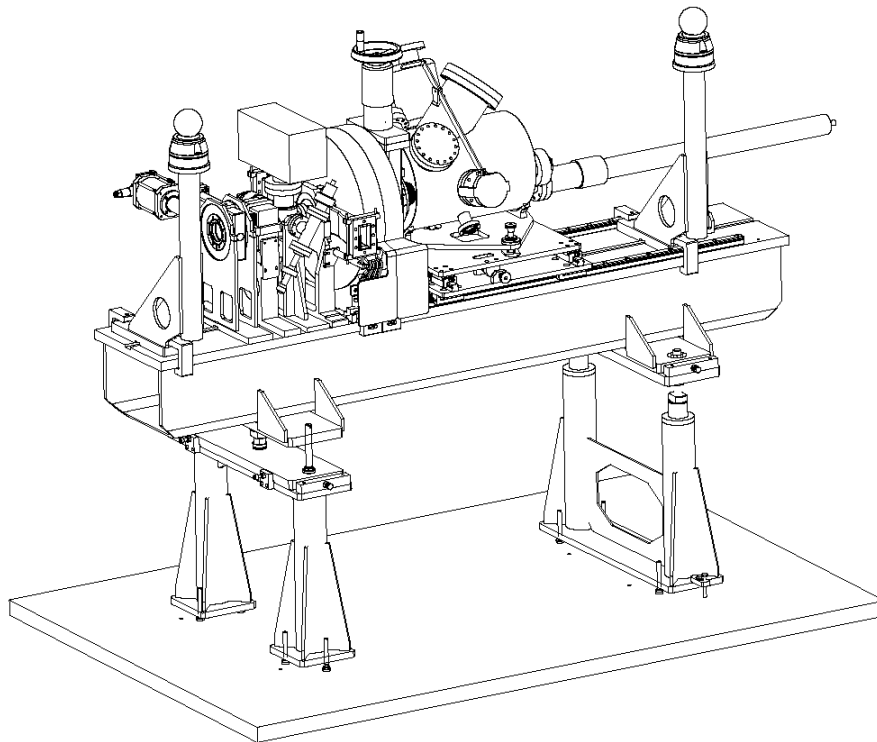

Figure 4: The CALIFE RF Photoinjector

5. Co-Evaporation Cs₂Te Photocathodes at the Photoemission Laboratory

Initially, the photocathodes were built by deposition of two consecutive layers of Te and Cs (in this order) on a Cu substrate. The resulting Cs₂Te chemical alloy was done itself by the reaction of the two compounds at room temperature. The Cs vapor flux had to be precisely managed with a good deposition rate for optimizing the maximum quantum efficiency of the alloy. (It has been checked that heating the plug and the alloy during the deposition does not improve the final result for a copper substrate).

Following an idea of G.Suberlucq, the co-evaporation (or co-deposition) technique aims to produce the photoemissive alloy by evaporating simultaneously the two compounds Te and Cs onto the Cu substrate (so-called “plug”). This process will be more efficient since the atomic vapors of the Cs and Te are mixed together before the deposition on the substrate.

The first test was initiated in summer 2001. Despite of the poor vacuum conditions and the basic setup, the first result reached immediately a QE value of 11% comparable to the values of the traditional dual layers photocathodes. Then, an intensive campaign of fabrication and measurements followed by the operation of the CTF2 drive-beam RF photoinjector with this type of photocathodes started to demonstrate the potential of this process [13].

The main ingredient for optimizing the photocathode during the coating is the possibility to produce an electron beam by illuminating the plug with laser light and collecting electrons with an anode. In addition, a measurement of the laser energy coupled with the collected charge measurement enables the quantum efficiency monitoring.

The latest improvement was the implementation of an online monitoring of the Te and Cs thickness during the vapor emission of the both compounds. A dedicated co-evaporation setup (Fig. 5) was designed and put into operation at the CERN photoemission laboratory in 2006. In this mechanical device, the Te and Cs evaporators are mounted together inside a mechanical mask. This mask enables the online monitoring of the Te and Cs thickness (Fig. 6) together during the vapor emission and ensures that the sensor for measuring the Cs thickness is shielded from the Te vapor and vice versa.

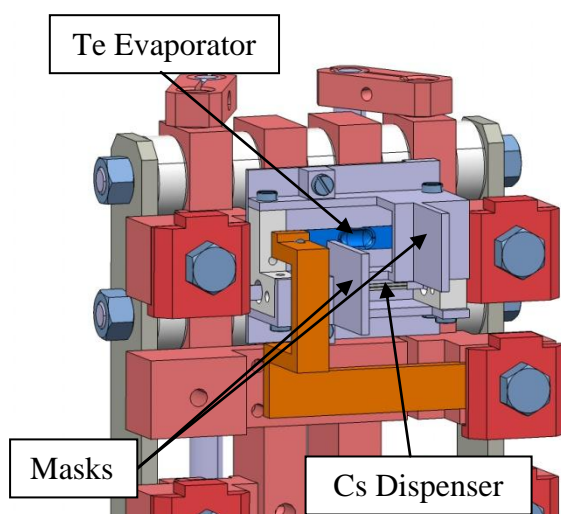

Figure 5: The co-evaporation setup

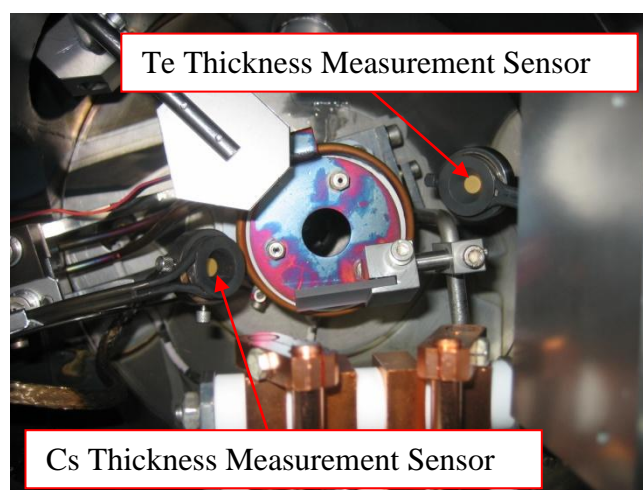

Figure 6: The two quartz sensors for the thickness measurement

5.1. The Photocathode Fabrication Process

The process starts by powering the power supplies dedicated for each evaporator (Te and Cs). By heating (joule effect) the Te evaporator and the Cs dispenser, the evaporation temperature is slowly reached. When an evaporation rate of ~0.1 nm/min is reached for the Te, the Cs power which stayed below the evaporation threshold is increased to the evaporation level.

Figure 7 shows a typical evolution of the power and the thickness as a function of time. When the Cs reaches the evaporation level, the QE begins to grow (Fig. 8).

The manipulations done during the trim of the Cs and Te vapor flow can be summarized by plotting the stoichiometric ratio (Fig. 8) which can be expressed as a function of the Cs and Te thickness:

$$\text{Stoichiometric Ratio}_{(\text{Cs}_2\text{Te})} = \frac{\text{ThicknessQuartz}(\text{Cs}) \times \text{Density}(\text{Cs}) \times \text{AtomicMass}(\text{Te})}{\text{ThicknessQuartz}(\text{Te}) \times \text{Density}(\text{Te}) \times \text{AtomicMass}(\text{Cs})}$$

$$\frac{\text{ThicknessQuartz}(\text{Cs})}{\text{ThicknessQuartz}(\text{Te})} = 2 \times \frac{6.25 \times 133}{1.9 \times 128} = 6.84$$

For a stoichiometric ratio = 2 (Cs₂Te case), the thickness ratio between Cs and Te must be 6.84. In practice to produce plots like Fig. 8 and 9, the thickness ratio is normalized to 2 and the derivative of the thickness is used instead of the thickness itself, which is the vapor flow (or the deposition speed) computed per minute. In this way the actual stoichiometry of the current layer is obtained instead of the global result integrated over the complete deposition cycle.

CERN Photoemission Laboratory - Cs₂Te Photocathode #173 - 27/01/2010
Thin Film Deposition in Co-Evaporation Mode
Evaporators Power and Thickness as a Function of Time

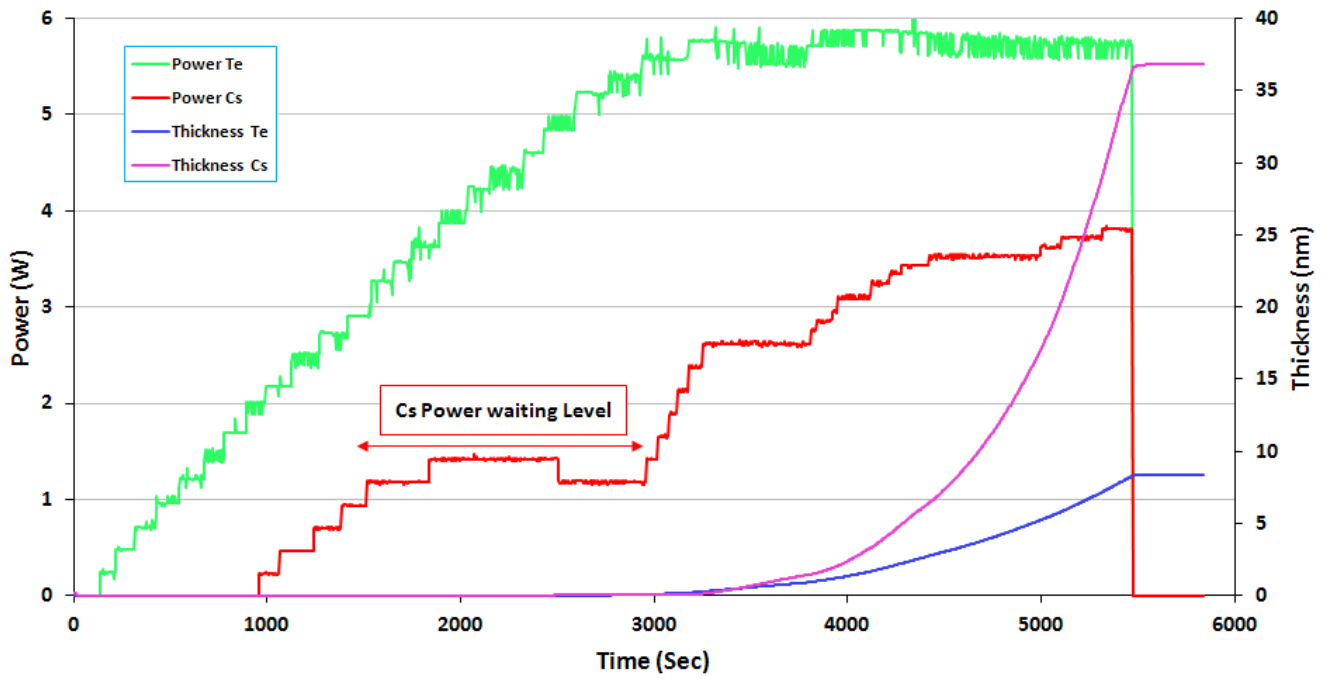

Figure 7: Te and Cs thickness evolution during the fabrication process for cathode #173

Quantum Efficiency and Stoichiometric Ratio growth during the Coating Process
Photocathode Cs₂Te #173 - 27/01/2010

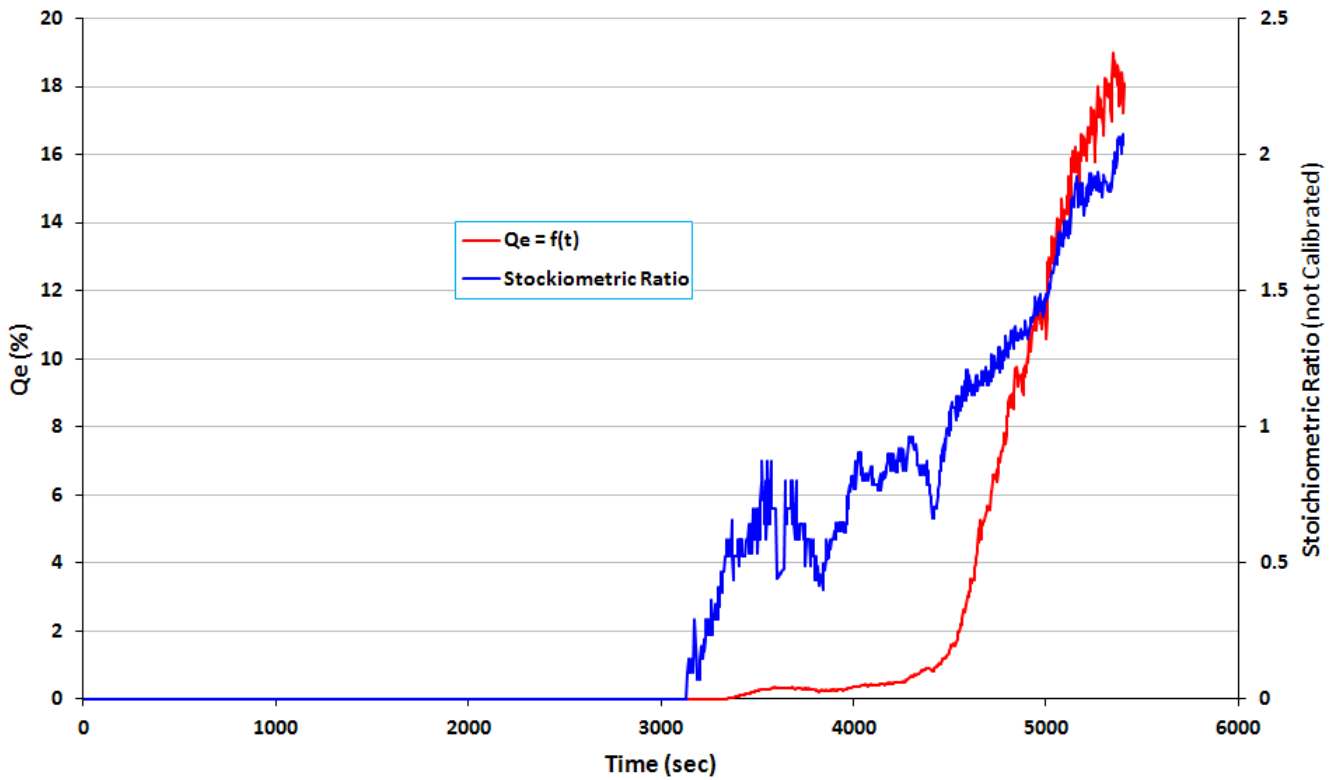

Figure 8: QE and stoichiometric ratio growth during the fabrication process as a function of time

5.2. Quantum Efficiency and Stoichiometric Ratio Growth during the Coating Process

The optimization of the photocathode is done by monitoring the QE. The quantum efficiency is maximized by manually adjusting the flow rate of the Cs vapor (using the dispenser's power supply), while the Te vapor flow is tentatively maintained approximately constant. (The time constant for the Te flow rate is high and on the other hand the Cs dispenser flow rate answer is faster).

By plotting the quantum efficiency and the stoichiometric ratio as a function of time, it can be clearly seen that increasing the stoichiometric ratio leads to increasing quantum efficiency (Fig. 8)

For Cs_2Te , the complete fabrication process is done at room temperature if a Cu substrate is used. It has been verified several times that heating does not improve the process and the resulting QE.

The quantum efficiency growth is very sensitive and a good stoichiometry needs to be preserved and improved. If not, it will result in a fast loss of the QE which can be sometimes difficult or impossible to correct (Fig. 9). Some cathodes were completely lost (low QE) because a good stoichiometry could not be retrieved.

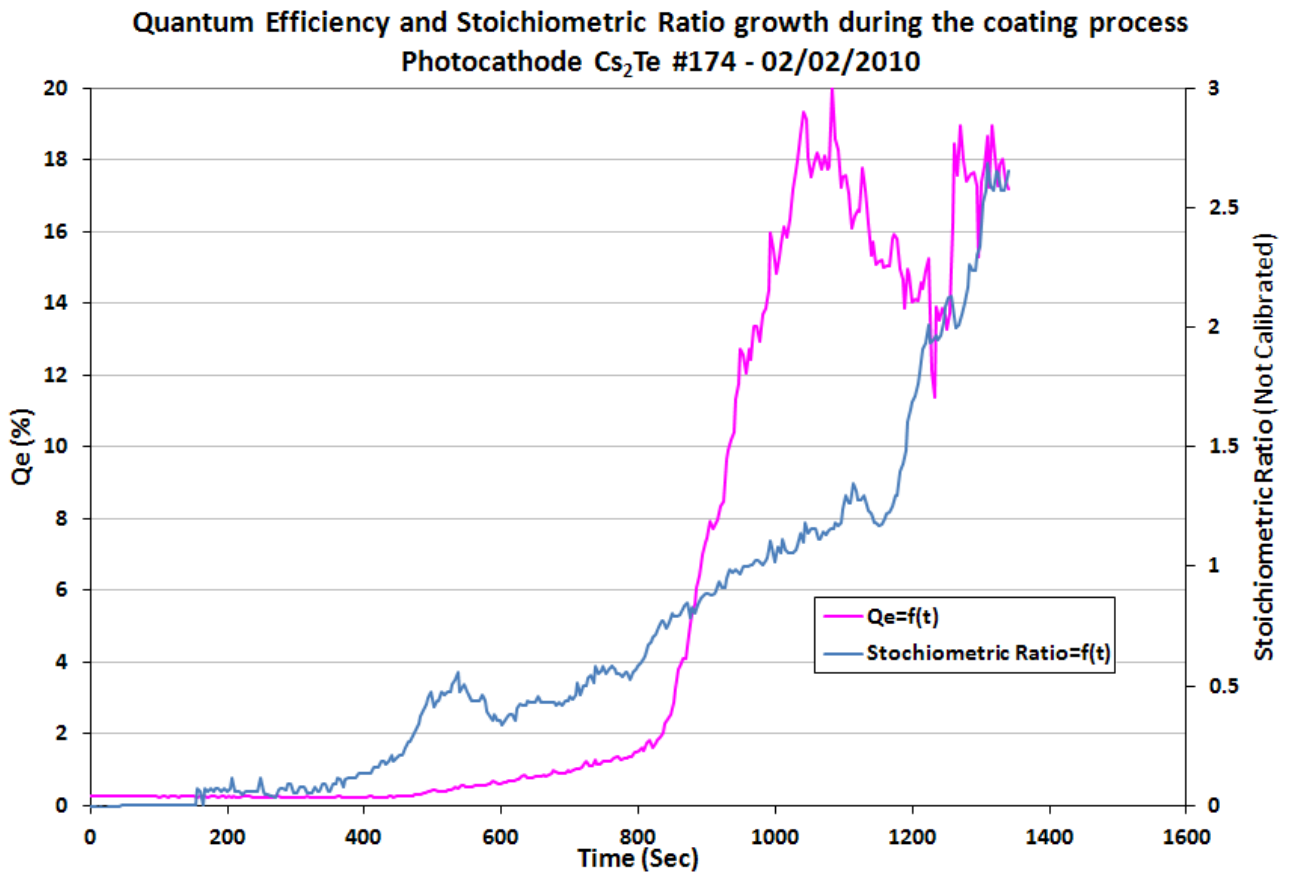

Figure 9: Example of loss of QE solved by increasing the stoichiometric ratio

It can be noted that the correlation of the behavior of the stoichiometric ratio (stoichiometry of the Cs and Te vapor mixture) and the quantum efficiency monitored together as shown Figure 8, 9 and 17 is good. Some events on the stoichiometry lead to some consequences on the resulting QE.

Remarks: Despite of the stable level of power supplied to the Te evaporator (Fig. 7 / green curve), the Te deposition rate is not stable during the entire process and poses a strong constraint onto the Cs deposition rate for preserving the stoichiometry.

The Cs and Te thicknesses are not calibrated and by consequence the vapor flow rates are not known with high accuracy. Because the thickness of each compound is monitored individually, it is possible to compute the stoichiometric ratio of the Cs and Te vapor mixture, as explained above. It is not the stoichiometry of the alloy itself deposited on the substrate but the stoichiometry of the Cs and Te vapor mixture monitored during the deposition. Like the vapor flow rate, the obtained values of the stoichiometric ratio are not very precise.

It has to be noted as well that the behavior of the vapor flow rate (or the thickness monitoring) seems to be not completely reproducible from one process to another. The reason is probably the filling of the Te evaporator (Mo basket), which induces some changes on the vapor flow seen by the quartz micro-balance.

When the maximum QE is reached, the process is stopped. If the Cs flow continues, no drastic increase of the QE will be observed. If too much Cs is deposited, then a dark current will begin to develop later during beam production in the DC Gun.

5.3. Beam Production and Photocathode Quantum Efficiency Measurements at the Photoemission Laboratory.

5.3.1. Beam Set-Up and Profiles

Immediately after the coating process, the new photocathode is transferred under vacuum, into the DC gun. The high-voltage conditioning of the new cathode begins by powering slowly the gun up to the nominal voltage of 80 kV. When the nominal voltage is reached, a low energy laser beam is sent to the cathode.

At this stage the beam monitoring is in operation and the solenoids for the beam transport are powered. The first step is to set up the beam with a good transverse beam profile using the scintillator screen (Fig. 10).

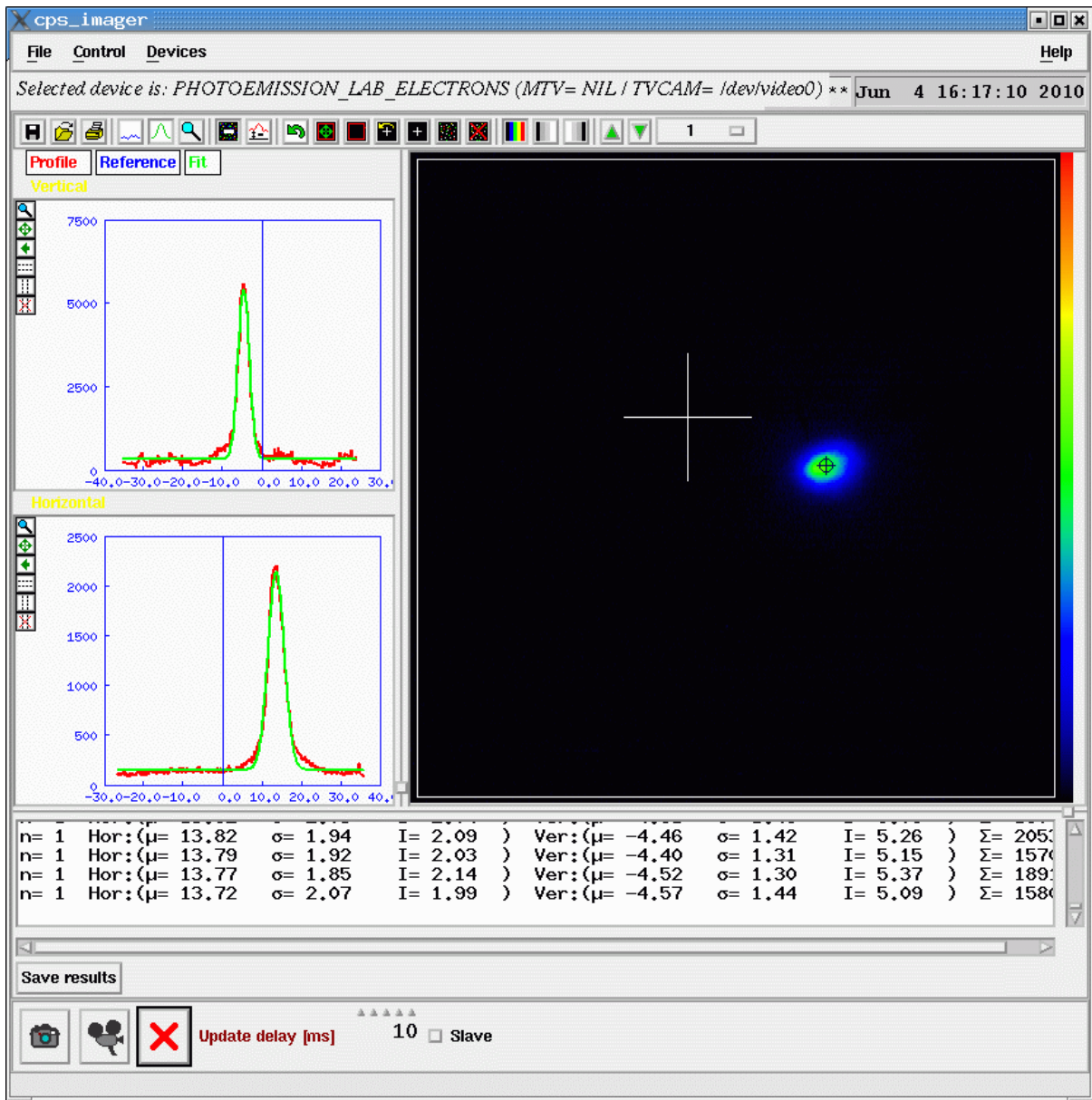

Figure 10: Electrons beam spot and its profiles visualized on a CsI(Tl) scintillator and digitized

5.3.2. Laser Beam Position

In a second step the laser beam must be well centered on the cathode. For this purpose, the charge is recorded as a function of the laser beam position in the horizontal and vertical plane by a dedicated application (Fig. 11). The laser beam position is controlled by moving two mirrors with a stepping motor translation stage, which are used for deflecting the beam horizontally and vertically.

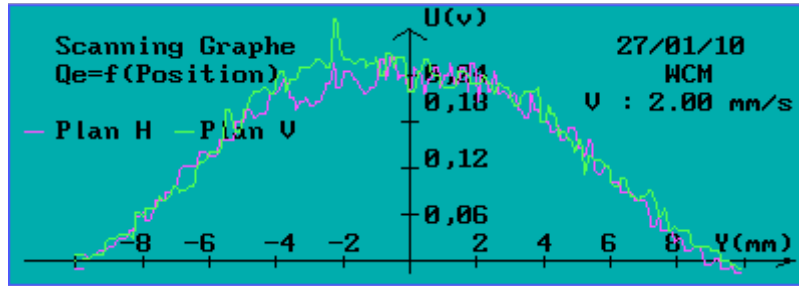

Figure 11: Charge as a function of the laser position (laser size: $\sigma = 2 \text{ mm}$)

5.3.3. Charge and QE Measurements

The next step will be to adjust the current of the focusing solenoids so that the complete beam is transported to the Faraday cup at the end of the beam line and the space charge is compensated, if needed. At this point the quantum efficiency can be computed (Table 2) by measuring the charge of the electron beam (Fig. 12) and the laser energy.

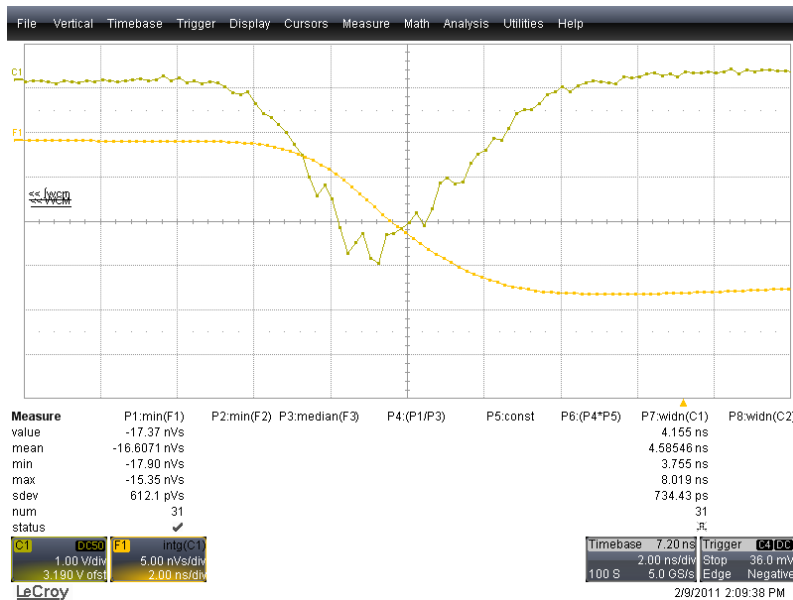

Figure 12: Example of measurement of the beam charge by the Wall Current Monitor

The charge can be measured either with a Faraday cup, a fast current transformer (FCT) or a wall current monitor (WCM). In the latter case the equation:

$$Q = \frac{\text{Min}(\int U_{\text{WCM}} dt)}{K}$$

will be used to compute the charge from the measured signal with $K = 4.77 \Omega$ [24] [25].

	WCM	FCT
Bunch Charge	2.91 nC	2.86 nC
Laser Energy	0.53 uJ	0.53 uJ
Quantum Efficiency	17.1 %	16.8 %

Table 2: Charge and quantum efficiency measurements for cathode 173 in the DC Gun

5.3.4. Life Time Measurements

To determine the life time of a photocathode, the quantum efficiency must be measured as a function of time until a decay of the QE is observed. Since the life time strongly depends on the vacuum and the vacuum in the DC gun is excellent, these measurements can take up some weeks in the photoemission laboratory. A further reason for the long life times is that the laser is pulsed only at 10 Hz (single pulse only, no bunch trains as in the PHIN photoinjector). A special study with 1 KHz repetition rate was performed in 2000 [26], but this dedicated setup is no longer available. So, the real test bench for the life time measurement is mainly the PHIN RF Photoinjector where the photocathode will be used under real conditions with bunch trains and the vacuum not as good as in the laboratory.

Figure 13 shows the quantum efficiency as a function of time which was recorded at PHIN for the photocathode 182. It was the first measurement of the life time in the PHIN photoinjector of a Cs₂Te cathode with a well controlled beam conditions (e.g. losses and vacuum) which give a preliminary value of $\tau_2 = 65$ h. It must be noted that after the measurements, the QE was still ~5%, which is above the CTF3 requirements of 3%. Better results with $\tau_2 = 300$ h which fulfill and exceed the CTF3 specifications were reached later in other runs [27].

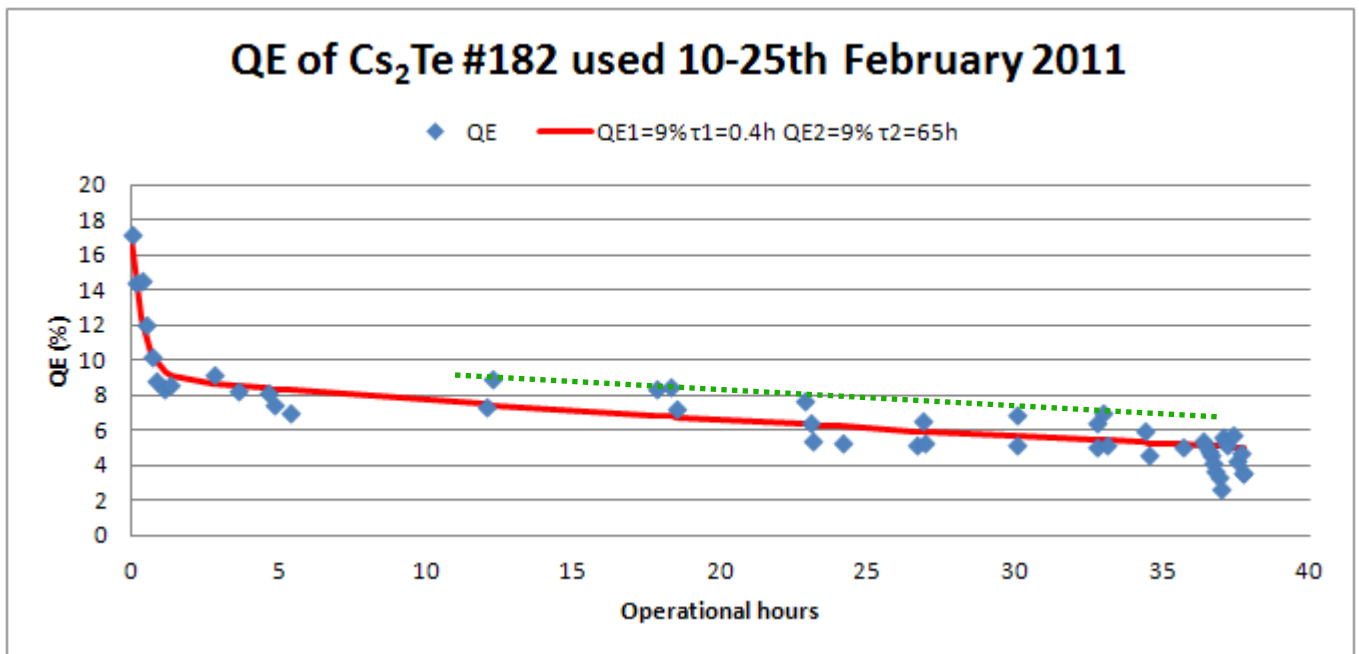

Figure 13: Life time measurements of the Cs₂Te cathode #182 at PHIN

The QE measurements were recorded with the operational RF phase (phase between the beam and the RF wave), adjusted for a good beam transport. In Fig. 13, the green dashed line shows the quantum efficiency measured when the RF phase is setup for extracting the maximum charge, which gives the maximum quantum efficiency. The time constant of the life time is evaluated using a fit to the measurement points taken with the operational phase (red curve Fig. 13).

5.4. Photocathode Work Overview from 2001 to Beginning 2012

This chapter highlights the photocathode production in the photoemission laboratory and in other CERN facilities during the last decade.

5.4.1. Photocathode Produced by Co-evaporation Mode

The photocathodes produced in co-evaporation mode and measured at the photoemission laboratory are summarized in Fig. 14. The graph shows the photocathode quantum efficiency for each cathode measured in the DC gun after the fabrication. The preliminary results with the Cs₃Sb at $\lambda=532$ nm will be described in more details in chapter 6.

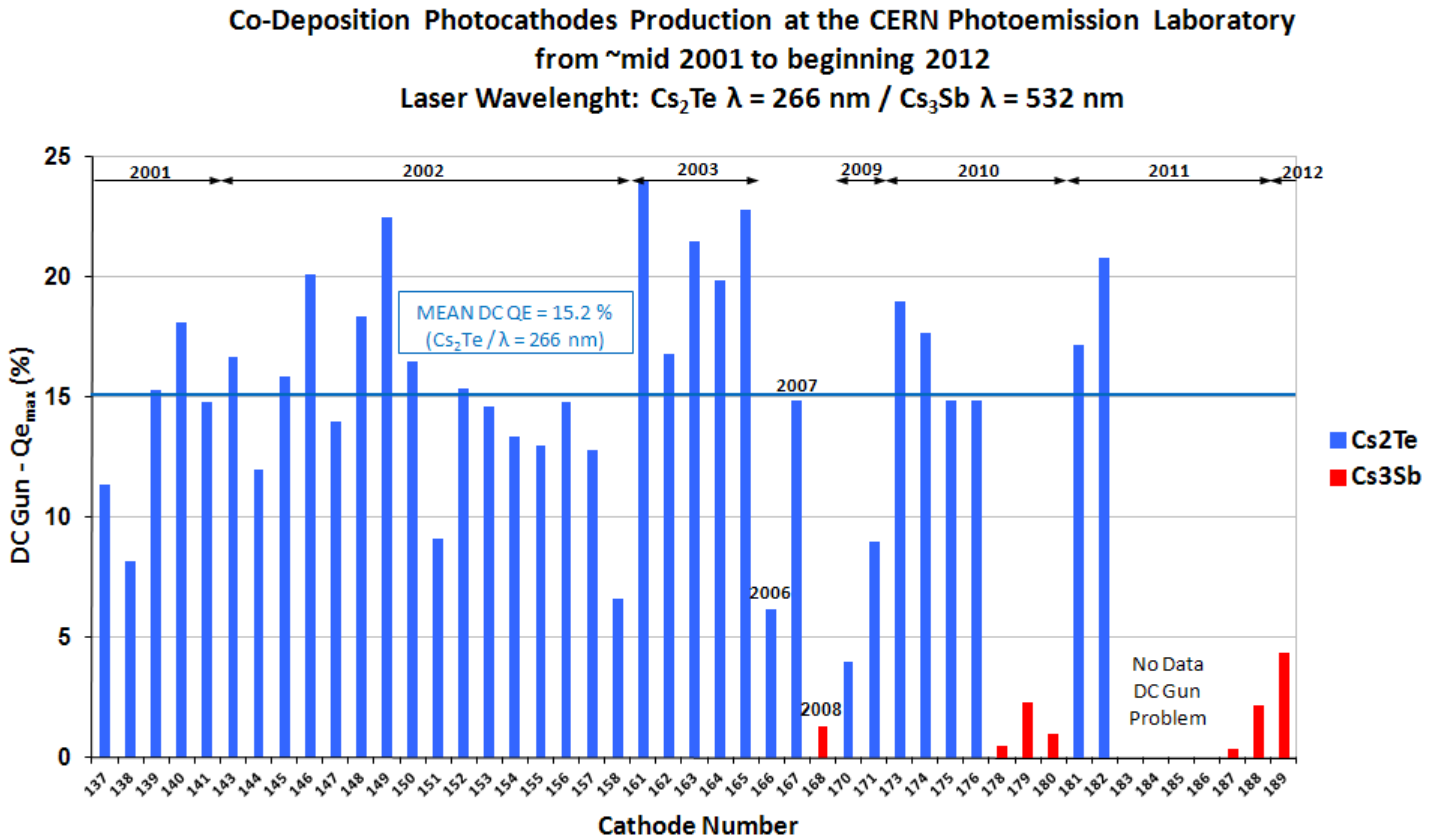

Figure 14: History of the co-evaporation photocathode production during the last decade

The mean DC QE for all the co-deposition Cs₂Te cathode production exhibits a QE = 15.2%. Nevertheless, the standard deviation of the production is high, 4.8%.

There is an interruption in the photocathodes production at year 2004 and 2005, when the photoemission laboratory has been renovated and a slow ramp-up from 2006 to 2010 during the PHIN photoinjector construction and commissioning. Other problems (hardware) slowed down the ramping-up of the production rate.

5.4.2. Other Photocathodes

During the same time scale other photocathode work was performed, which is shown in Fig. 15.

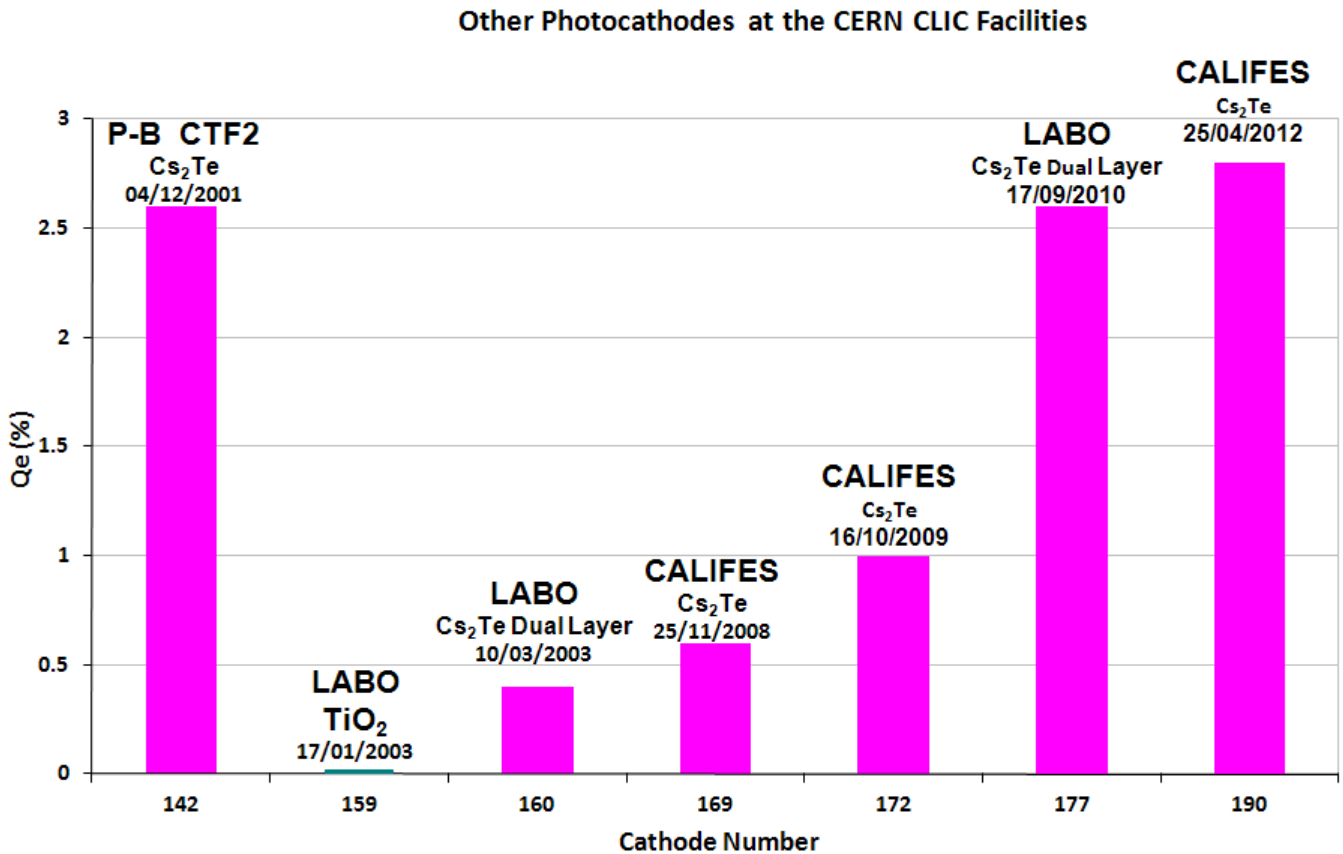

Figure 15: Other photocathodes produced at the CERN CLIC Facilities

- CTF2 probe-beam and CALIFES photocathode production in blind mode, (no optimization on QE) Cs₂Te photocathodes in two consecutive layers. Modest QE were achieved with a stable value of 0.3% reached after a few weeks of operation.
- Re-visit the standard dual layer photocathodes (no co-evaporation) in the photoemission laboratory.
- Exotic test with TiO₂ (QE not at scale on the graph) QE ~ 10⁻⁴ % with $\lambda=266$ nm

The photocathode production in blind mode demonstrates the possibility to operate a photoinjector as electron source with a limited technical installation at least for the photocathode part. The price to pay is the very low QE (0.3%) available after a few weeks of operation. However, this value is relatively stable over an entire year.

5.5. Photocathode Quantum Efficiency in the DC (Laboratory) and RF Gun (PHIN)

In Fig. 16 the comparison of the starting QE in the DC gun and the RF gun for Cs₂Te co-deposition photocathodes is summarized. The discrepancy between the DC and RF measurements is commented as indicated below:

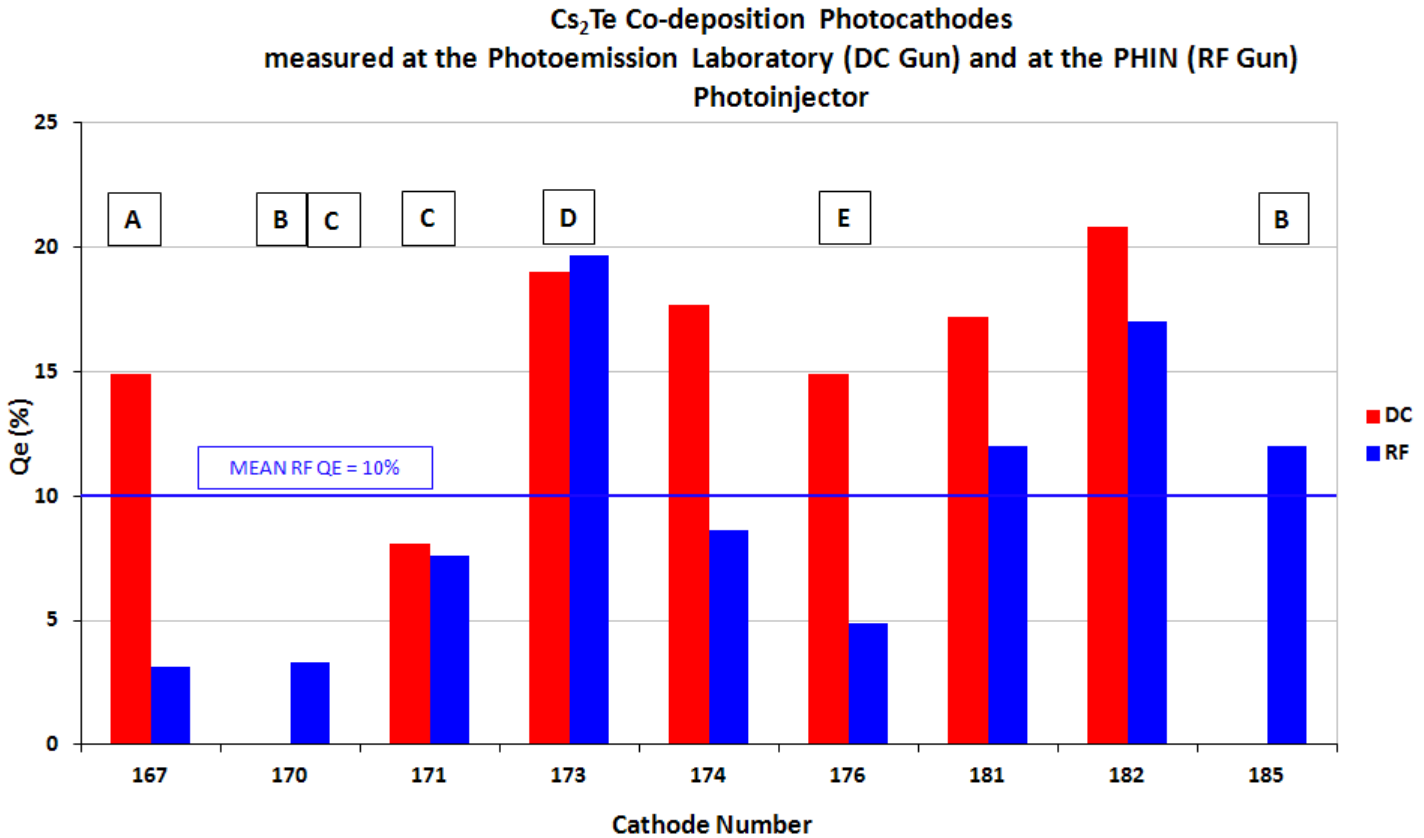

Figure 16: Comparison between QE in DC and RF for Cs₂Te co-deposition photocathodes

- A) First photocathode used at PHIN. In the RF gun the laser beam was reflected on the pipe before impinging onto the cathode. Therefore, only a fraction of the laser beam hit the photocathode, which induced a low RF QE measurement result.
- B) DC Gun damaged, no DC data available
- C) Not enough Cs available, dispenser already used for another cathode
- D) The QE in the DC gun was lower than in the RF gun, because the WCM measurement was distorted by a bad continuity of the wall chamber (ceramic insertion and its by-pass shielding was not efficient) and possibly due to a non-optimal beam transport.
- E) Low QE measurement in the RF gun because of we experiment heavy difficulties during the RF conditioning (sparking) of the cathode. This was probably due to a bad cleaning, which polluted the substrate.

Despite the discrepancies between QE value in DC and RF guns, it has been demonstrated that high QE can be achieved in RF gun with relatively long life time. The mean QE in PHIN is about 10%. Due to the limited availability of PHIN, the statistic is relatively poor.

6. Prospects with Cs₃Sb Photocathodes in Co-deposition Mode at the Photoemission Laboratory

The motivation for re-visit the well known Cs₃Sb photocathodes [28] is driven by the CLIC requirements. If it is possible to use Cs₃Sb photocathodes with a laser wavelength of $\lambda=532$ nm (green) in an RF Gun with a reasonable life time, then the requirements on the laser system could be relaxed:

- To produce the same electron bunch charge, laser pulses with a factor ~ 6 less in the energy would be needed:
 - o A factor 2 would be gained directly from equation because the wavelength is shifted from 266 nm to 532 nm

$$QE (\%) = \frac{124 \times Q (\text{nC})}{\lambda (\text{nm}) \times E (\text{uJ})} \qquad E (\text{uJ}) = \frac{124 \times Q (\text{nC})}{\lambda (\text{nm}) \times Qe (\%)}$$

With the CTF3 parameters $Q = 2.3$ nC and $QE = 3 \%$:

$$E_{(266\text{nm})} = \frac{124 \times 2.3}{266 \times 3} \qquad E_{(266\text{nm})} = 0.357 \text{ uJ}$$

$$E_{(532\text{nm})} = \frac{124 \times 2.3}{532 \times 3} \qquad E_{(532\text{nm})} = 0.179 \text{ uJ}$$

For the same charge extracted, a photocathode with the same QE which work in the green at $\lambda=532$ nm need a factor two less in laser energy.

- o Another factor 3 would be gained because the frequency conversion stage from green to UV light is not needed in the laser system. This frequency conversion has in general an efficiency of $\sim 30\%$.
- The crystal damage threshold will be more relaxed for the CLIC laser beam
- The laser stability will be better and easier to control.
- The laser beam transport will be easier to align and more efficient

Compared with the old studies of Cs₃Sb cathodes, new possibilities to produce these Cs₃Sb cathodes are available in the photoemission laboratory:

- Co-evaporation (which is new for these cathode type)
- Quantum efficiency optimization directly on the operating wavelength $\lambda=532$ nm
- Excellent vacuum conditions (Preparation chamber / DC gun / Transport carrier)
- Full computing of the process
- Possibility to perform beam studies on-site at the RF photoinjector PHIN, with the full range of beam diagnostic equipment available.

The first Cs₃Sb co-deposition cathode was produced in January 2008, at this first time still without heating of the cathode plug. All subsequent Cs₃Sb on copper substrate, which yielded good results, were produced with heating (See Table 3). At the moment, it is not yet clear if the heating is mandatory to achieve good results with this cathode type on copper plugs.

6.1. Quantum Efficiency and Stoichiometric Ratio Growth during the Coating Process

The same rules as for Cs₂Te are applied for producing the Cs₃Sb photocathodes where antimony replaces the tellurium. The only differences are that the cathode is heated (~120 °C) during the process and the QE is monitored with a laser beam with 532 nm wavelength.

**Quantum Efficiency and Stoichiometric Ratio growth during the coating process
Photocathode Cs₃Sb #180 - 09/12/2010**

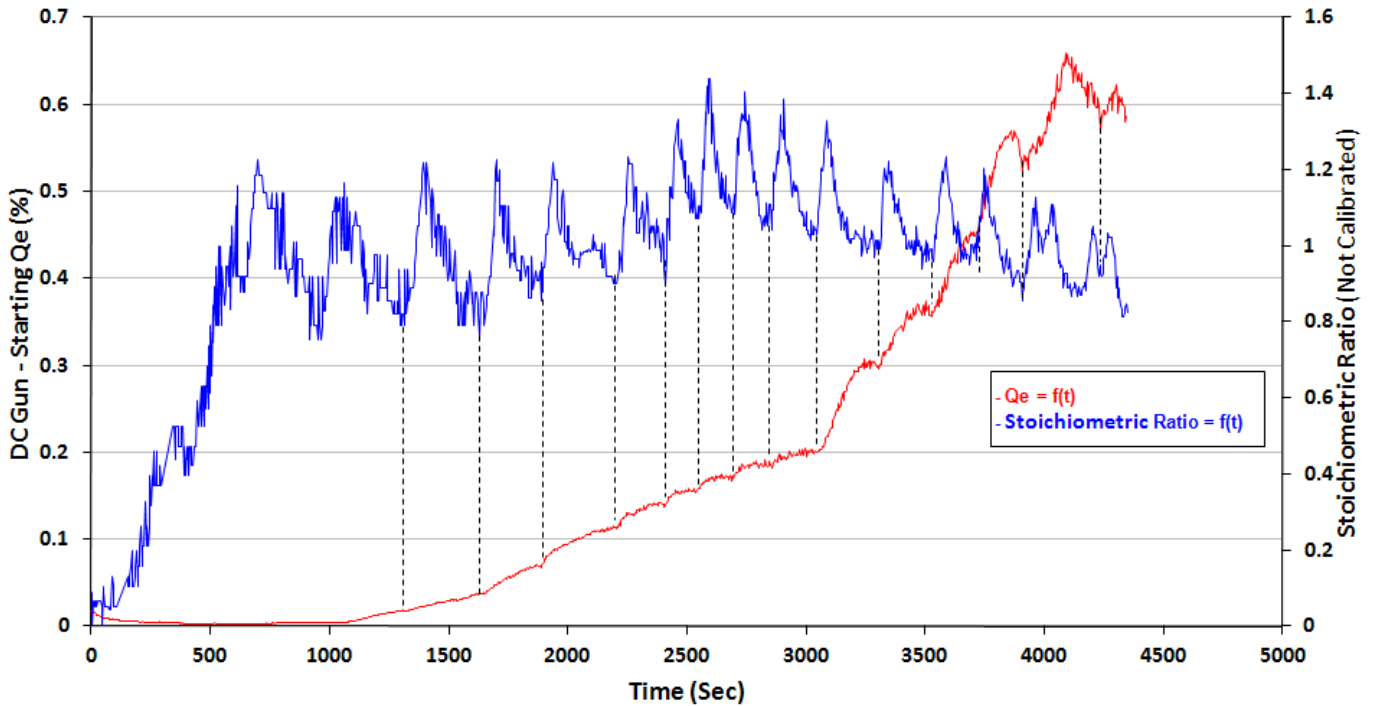

Figure 17: QE and stoichiometric ratio growth as a function of time during the Cs₃Sb fabrication process

There exists a good correlation between the behavior of the stoichiometric ratio and the quantum efficiency (Fig. 17 dashed line): The QE behavior follows the stoichiometric ratio, the QE rises if the ratio is increased or decreases if the ratio drops.

The behavior of the stoichiometric ratio can be explained by the limited flow rate available from the Cs dispenser because it was already used for a previous cathode. Furthermore, the Cs₃Sb stoichiometry requires more Cs than Cs₂Te.

6.2. Beam Measurements at the Photoemission Laboratory with Cs₃Sb Photocathodes

Seven Cs₃Sb photocathodes were produced as shown in Table 3 and Fig. 20:

Cathode Number	Date	Type	λ (nm)	Starting QE (%)	Max QE (%)	Heating
168	17/01/2008	Cs ₃ Sb	532	0.8	1.3	No
178	19/11/2010	Cs ₃ Sb	532	0.3	0.5	No
179	25/11/2010	Cs ₃ Sb	532	1.4	2.3	Yes
180	09/12/2010	Cs ₃ Sb	532	0.6	1	Yes
187	08/12/2011	Cs ₃ Sb	532	0.3	0.4	Yes
188	15/12/2011	Cs ₃ Sb	532	1.3	2.2	Yes
189	11/01/2012	Cs ₃ Sb	532	2.3	4.4	Yes

Table 3: Summary of the results with the Cs₃Sb Photocathode at 70 keV in the DC gun

6.3. Life Time and QE as a Function of Time in the DC Gun at $\lambda=532$ nm

- For each cathode, an increase of the starting QE (close to factor ~ 2) was observed at the beginning of the life of the cathode (Fig. 18 and 19) during its operation in the DC gun. At this stage, it is not possible to conclude if this is a cleaning effect or more probably a part of the Cs_3Sb alloy formation.
- It has turned out that the QE could be well conserved during a long storage period under UHV conditions ($p=7 \times 10^{-12}$ mbar) as shown Fig. 18 (Blue area).
- The initial maximum QE value of up to 4.4% at $\lambda=532$ nm is promising (Best cathode Fig. 19)

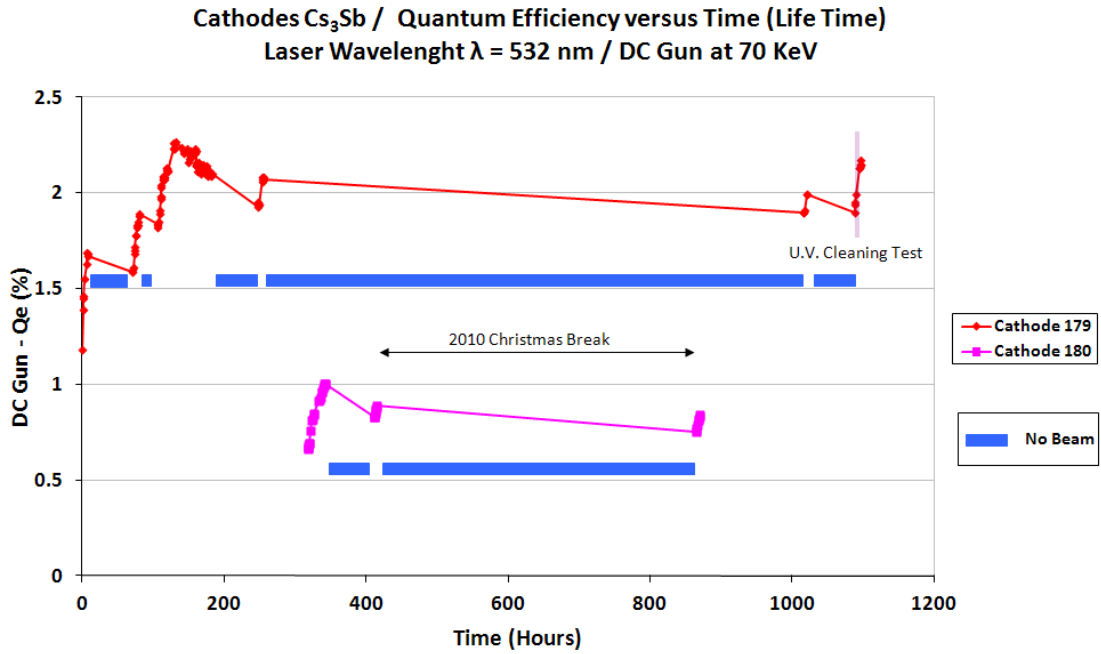

Figure 18: Photocathodes Cs_3Sb / QE as a function of time with 70 keV beam in the DC gun

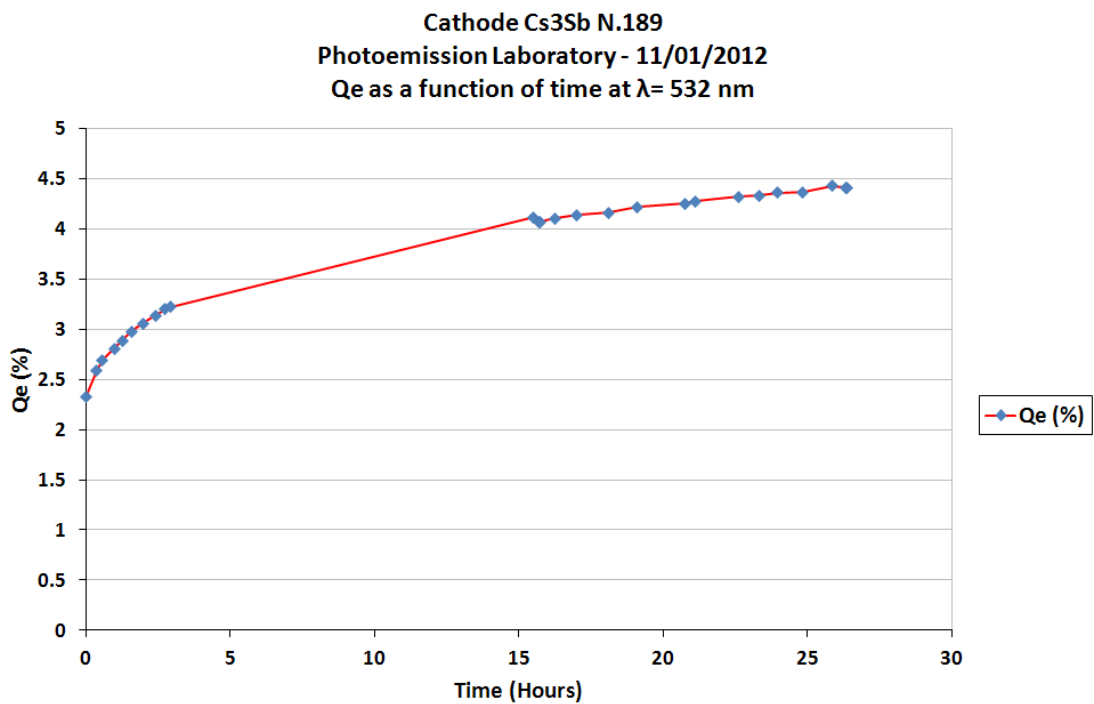

Figure 19: Photocathode Cs_3Sb #189 – Behavior of the QE as a function of time during the first hours of the cathode (Beam produced continuously with a charge of ~ 20 nC/bunch at 10 Hz)

6.4. Co-Deposition Cs₃Sb Photocathode Production Overview

An overview is shown in Fig. 20 of the Cs₃Sb co-deposition photocathodes produced in the CERN photoemission laboratory with their maximum quantum efficiency in the DC Gun at 70 keV and their starting QE in the PHIN RF photoinjector.

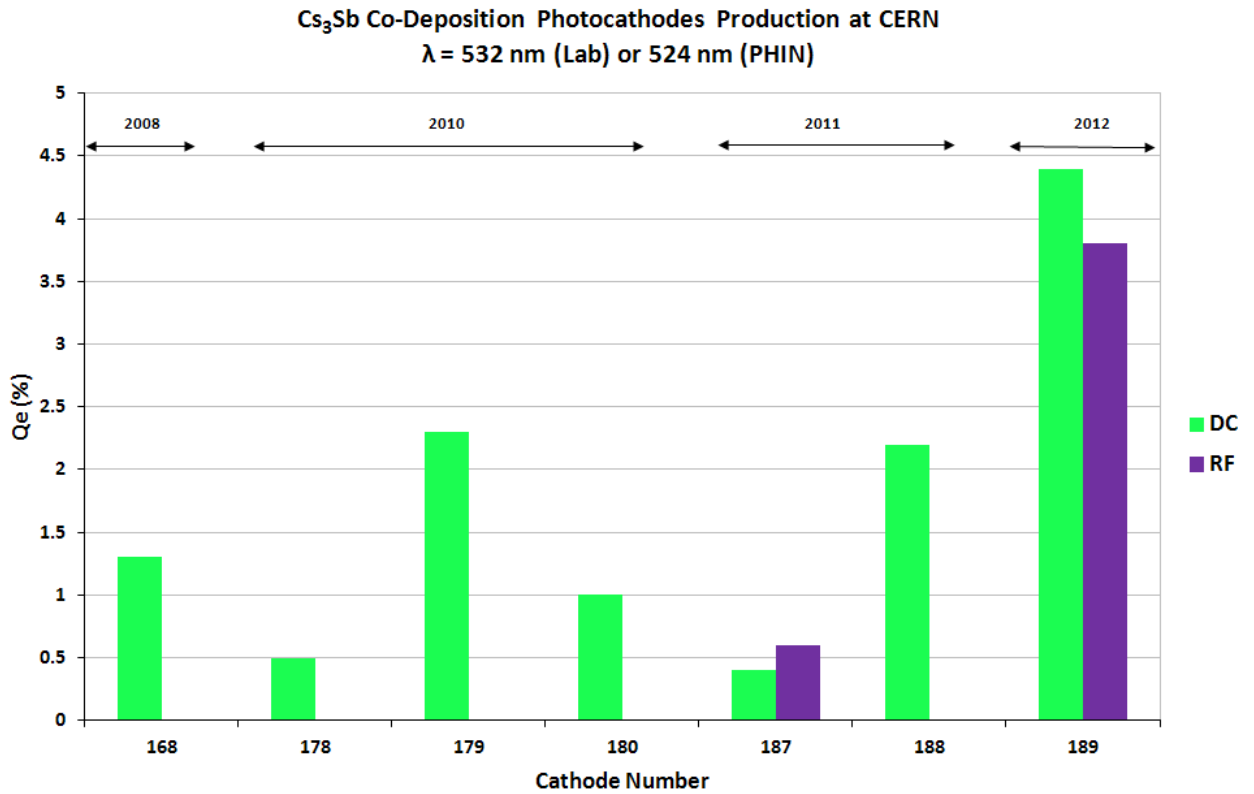

Figure 20: History of the co-deposition Cs₃Sb photocathode production

6.5. Beam Measurements with Cs₃Sb Photocathode at the PHIN Photoinjector

The main issue of this kind of cathode is the life time. First measurements were performed at the PHIN RF photoinjector with a laser beam with $\lambda=524 \text{ nm}$ wavelength in March 2012. A preliminary analysis of the data indicates a life time of the co-deposition Cs₃Sb photocathode similar to the life time of the Cs₂Te photocathodes which is an important and unexpected result. Data analysis and the preparation of new extensive measurements are on-going.

7. Conclusion

Despite of the end of the former CTF2 studies, the Cs₂Te alkali photocathodes built in co-deposition have now fully demonstrated at PHIN their good performance in term of QE and life time to produce intense electron beams. The price to pay for using these cathodes is a good vacuum in and at the output of the RF gun and a state-of-the-art technical laboratory for their production. With these prerequisites, the roadmap for demonstrating the feasibility of a photoinjector as the CLIC drive beam source is given: The vacuum quality in the RF gun during beam operation must be improved. Nevertheless, it seems difficult to verify the CLIC drive beam requirements of 140 us long bunch trains with a repetition rate of 50 Hz, without a new dedicated CLIC RF gun. On the other hand, the possibilities of the Cs₃Sb photocathodes produced in co-deposition mode and used with green laser light show attractive prospects for the whole photoinjector community and could be a major progress in this field.

Acknowledgments

The author would like to thank for their help M.Csatari, C.Heßler, M. Petrarca; for their supports K.Elsener, V.Fedosseev, R.Losito; last but not the least, for his expertise and advices G.Suberlucq.

We acknowledge the support of the European Community-Research Infrastructure Activity under the FP6 “Structuring the European Research Area” programme (CARE, contract number RII3-CT-2003-506395).

References:

- [1] G. Guignard (ed.), “A 3 TeV e+e- Linear Collider Based on CLIC Technology”, CERN-2000-08, CERN, Geneva, 2000 <http://cdsweb.cern.ch/record/461450/files/CERN-2000-008.pdf?version=1>
- [2] I.Wilson, “The compact linear collider CLIC”, Phys. Rep. 403-404 (2004) P.365.
<http://dx.doi.org/10.1016/j.physrep.2004.08.028>
- [3] H.Braun et al., “CLIC 2008 Parameters” CLIC-Note-764, CERN, Geneva, 2008,
<http://cdsweb.cern.ch/record/1132079/files/CERN-OPEN-2008-021.pdf>
- [4] Y.Baconnier, K.Geissler, K.Hübner, JHB. Madsen, “A CLIC Injector Test Facility”, CLIC Note 65, CERN, Geneva, 1988, <https://cdsweb.cern.ch/record/255117/files/198902466.pdf>
- [5] R.Roux, G.Bienvenu, C.Prevost, B.Mercier, “Design of a RF Photo-Gun”, CARE Note-2004-034-PHIN, 2004, <http://cdsweb.cern.ch/record/941433/files/note-2004-034-PHIN.pdf>
- [6] I.N. Ross, “Feasibility Study for the CERN ’CLIC’ Photo-Injector Laser System”, CLIC Note 462, CERN, Geneva, 2000 <http://cdsweb.cern.ch/record/467721/files/open-2000-301.pdf>
- [7] G. Kurdi, I.O. Musgrave, M. Divall, E. Springate, W. Martin, G.J. Hirst, I.N. Ross, “Development of the CTF3 photo-injector laser system”, STFC CLF annual report (2007) pp. 225
http://www.clf.rl.ac.uk/resources/PDF/ar06-07_s7rdi_ctf3photoinjector.pdf
- [8] M.Csatari Divall et al., “Fast phase switching within the bunch train of the PHIN photo-injector at CERN using fiber-optic modulators on the drive laser”, Nucl. Instr. And Meth. A 659 (2011) p. 1.
<http://dx.doi.org/10.1016/j.nima.2011.09.006>
- [9] Y.Baconnier, A.Pisent, “CLIC Test Facility / the Photocathode Test Bench”, CLIC Note 104, CERN, Geneva, 1989 <http://cdsweb.cern.ch/record/255070/files/CM-P00064743.pdf>
- [10] Y.Baconnier, K.Geissler, JHB. Madsen, A.Pisent, G.Suberlucq, “CLIC Studies – The DC test bench for laser driven photoemissive cathodes”, CLIC Note 116, Proc. EPAC 1990, p. 688
http://accelconf.web.cern.ch/accelconf/e90/PDF/EPAC1990_0688.pdf
- [11] G. Suberlucq et al., "Photocathodes tested in the dc gun of the CERN photoemission laboratory", Nucl. Instr. and Meth. A340 (1994) 146-156, [http://dx.doi.org/10.1016/0168-9002\(94\)91293-9](http://dx.doi.org/10.1016/0168-9002(94)91293-9)
- [12] G.Suberlucq, “Développement et production de photocathodes pour le CLIC Test Facility”, CLIC Note 299, CERN, Geneva, 1996, https://edms.cern.ch/file/831563/1/CLIC_Note_299.pdf
- [13] G.Suberlucq, “Technological Challenges for high brightness photo-injectors”, Proc. EPAC 2004, p. 64, <http://accelconf.web.cern.ch/accelconf/e04/PAPERS/TUYBCH02.pdf>

- [14] R. Bossart et al., “Demonstration of Two-Beam Acceleration in CTF II”, CLIC Note 375, 24.08.1998, Proc. Linac 1998, <http://cdsweb.cern.ch/record/364527?ln=en>
- [15] G. Geschonke, A. Ghigo, “CTF3 design report” CTF3 Note 2002-047, CERN, Geneva, 2002, <http://cdsweb.cern.ch/record/559331/files/ps-2002-008.pdf?version=3>
- [16] H.H. Braun et al., “The Photo-Injector Option for CLIC: Past Experiments and Future Developments”, Proceedings of the 2001 Particle Accelerator Conference, Chicago, p. 720, <http://accelconf.web.cern.ch/accelconf/p01/PAPERS/FOAC003.pdf>
- [17] R. Losito et al., « THE PHIN Photo-Injector for the CTF3 Drive Beam”, CARE Conf-06-019-PHIN, Proc. EPAC 2006, p. 2517, <http://accelconf.web.cern.ch/accelconf/e06/PAPERS/WEPLS059.pdf>
- [18] M. Csatari Divall et al., “High charge PHIN photo injector at CERN with fast phase switching within the bunch train for beam combination”, Proc. IPAC 2011, p. 430, <http://accelconf.web.cern.ch/accelconf/IPAC2011/papers/mopc150.pdf>
- [19] A.di Bona et al., “Auger and x-ray photoemission spectroscopy study on Cs₂Te Photocathodes”, J. Appl. Phys. 80 (1996) p. 3024, http://jap.aip.org/resource/1/japiau/v80/i5/p3024_s1
- [20] C. Travier, “An introduction to photo-injector design”, Nucl. Instr. and Meth. A 340 (1994) p. 26, [http://dx.doi.org/10.1016/0168-9002\(94\)91278-5](http://dx.doi.org/10.1016/0168-9002(94)91278-5)
- [21] R.Bossart et al., “A 3 GHZ photoelectron gun for high beam intensity”, Proc. 17th Int Free Electron Laser Conf., Nucl. Instr. and Meth. A 375 (1996) ABS 7, [http://dx.doi.org/10.1016/0168-9002\(95\)01369-5](http://dx.doi.org/10.1016/0168-9002(95)01369-5)
- [22] G. Suberlucq et al., “Dark Current Measurements”, CLIC Meeting 08/07/2003 https://edms.cern.ch/file/891459/1/GSuberlucq_CTF2_dark_current_08July2003.pdf
- [23] J. Brossard et al, “Construction of the Probe-Beam Photoinjector of CTF3”, Proc. EPAC 2006, MOPLS114, <http://accelconf.web.cern.ch/AccelConf/e06/PAPERS/MOPLS114.pdf>
- [24] J.Durand et al., “A 10 GHz Wall Current Monitor”, PS/LP/Note 95-09 (Tech), CERN, Geneva, 1995 <http://cdsweb.cern.ch/record/1368236/files/CERN-PS-LP-note-95-09.pdf>
- [25] J. Durand, “Utilisation du Wall Current Monitor au Laboratoire de Photoémission PS-LP” PS/LP Note 91-10, CERN, Geneva, 1991, https://edms.cern.ch/file/832423/1/JDurand_PS_LP_1991_WCM.pdf
- [26] G. Suberlucq et al., “Production of a High Average Current Electron Beam with Cs-Te Photocathodes”, CTF3 Note 020, CERN, Geneva, 2001, <https://edms.cern.ch/file/831570/3/>
- [27] C. Heßler et al., “Lifetime Studies of Cs₂Te Cathodes at the PHIN RF Photoinjector at CERN, Proc. IPAC 2012, p 1554, <http://accelconf.web.cern.ch/accelconf/IPAC2012/papers/tuppd066.pdf>
- [28] M.Millérioux, “Photoémission et Photocathodes”, Internal report, CEA-DAM, Ile de France, 2003 https://edms.cern.ch/file/837930/2/La_photoemission_classique_CEA.pdf